

# **GA - 586STX**

## **USER'S MANUAL**

- \* Auto detect CPU Voltage.
- \* Support MMX CPU.
- \* Switching mode Voltage regulator on Board.
- \* Modem-Ring-On on COM2.
- \* Support Cyrix / IBM 6x86MX & AMD-K6 CPU.

**Pentium<sup>®</sup> Processor PCI - ISA BUS MAINBOARD**

**REV. 1.0 Third Edition**

**Release Date 97.08.20**

**I. Quick Installation Guide:**

CPU	SW1	SW2	SW3	SW4	SW5	SW6	SW7	SW8
1. Pentium <sup>®</sup> Processor 90 MHz	ON	OFF	OFF	OFF	OFF	OFF	ON	OFF
2. Pentium <sup>®</sup> Processor 100 MHz	OFF	OFF	OFF	OFF	OFF	OFF	ON	OFF
3. Pentium <sup>®</sup> Processor 120 MHz	ON	ON	OFF	OFF	OFF	OFF	ON	OFF
4. Pentium <sup>®</sup> Processor 133 MHz	OFF	ON	OFF	OFF	OFF	OFF	ON	OFF
5. Pentium <sup>®</sup> Processor 150 MHz	ON	ON	ON	OFF	OFF	OFF	ON	OFF
6. Pentium <sup>®</sup> Processor 166 MHz	OFF	ON	ON	OFF	OFF	OFF	ON	OFF
7. Pentium <sup>®</sup> Processor 180 MHz	ON	OFF	ON	OFF	OFF	OFF	ON	OFF
8. Pentium <sup>®</sup> Processor 200 MHz	OFF	OFF	ON	OFF	OFF	OFF	ON	OFF
9. Intel MMX-150MHz	ON	ON	ON	OFF	OFF	OFF	ON	OFF
10. Intel MMX-166MHz	OFF	ON	ON	OFF	OFF	OFF	ON	OFF
11. Intel MMX-200MHz	OFF	OFF	ON	OFF	OFF	OFF	ON	OFF
12. Intel MMX-233MHz	OFF	OFF	OFF	OFF	OFF	OFF	ON	OFF
13. P54CT-150 MHz	ON	ON	ON	OFF	OFF	OFF	ON	OFF
14. P54CT-166 MHz	OFF	ON	ON	OFF	OFF	OFF	ON	OFF
15. P54CTB-150 MHz	ON	ON	ON	OFF	OFF	OFF	ON	OFF
16. P54CTB-166 MHz	OFF	ON	ON	OFF	OFF	OFF	ON	OFF
17. P54CTB-180 MHz	ON	OFF	ON	OFF	OFF	OFF	ON	OFF
18. P54CTB-200 MHz	OFF	OFF	ON	OFF	OFF	OFF	ON	OFF
19. AMDK5-PR133	OFF	ON	OFF	OFF	OFF	OFF	ON	OFF

Table of Contents

20. AMDK5-PR166	OFF	ON	ON	OFF	OFF	OFF	ON	OFF
-----------------	-----	----	----	-----	-----	-----	----	-----

CPU	SW1	SW2	SW3	SW4	SW5	SW6	SW7	SW8
21. AMD-K6/166 (2.9V)	OFF	ON	ON	OFF	OFF	ON	ON	OFF
22. AMD-K6/180 (2.9V)	ON	OFF	ON	OFF	OFF	ON	ON	OFF
23. .AMD-K6/200 (2.9V)	OFF	OFF	ON	OFF	OFF	ON	ON	OFF
24. AMD-K6/233 (3.2V)	OFF	OFF	OFF	ON	OFF	OFF	ON	OFF
25. Cyrix / IBM 6x86-120 MHz-PR150+	ON	ON	OFF	OFF	OFF	OFF	ON	OFF
26. Cyrix / IBM 6x86-133 MHz-PR166+	OFF	ON	OFF	OFF	OFF	OFF	ON	OFF
27. Cyrix / IBM 6x86-150 MHz-PR200+ *	OFF	ON	OFF	OFF	OFF	OFF	ON	OFF
28. Cyrix / IBM 6x86L- PR150+ (2.8V)	ON	ON	OFF	OFF	OFF	OFF	ON	OFF
29. Cyrix / IBM 6x86L-PR166+ (2.8V)	OFF	ON	OFF	OFF	OFF	OFF	ON	OFF
30. Cyrix/ IBM 6x86L-PR200+ (2.8V) *	OFF	ON	OFF	OFF	OFF	OFF	ON	OFF
31. Cyrix/IBM 6x86MX-PR166 (60*2.5 2.9V)	ON	ON	ON	OFF	OFF	ON	ON	OFF
32. Cyrix/IBM 6x86MX-PR200 (66*2.5 2.9V)	OFF	ON	ON	OFF	OFF	ON	ON	OFF
33. Cyrix/IBM 6x86MX-PR200 (75*2 2.9V)*	OFF	ON	OFF	OFF	OFF	ON	ON	OFF
34. Cyrix/IBM 6x86MX-PR233 (66*3 2.9V)	OFF	OFF	ON	OFF	OFF	ON	ON	OFF
35. Cyrix/IBM 6x86MX-PR233 (75*2.5 2.9V)*	OFF	ON	ON	OFF	OFF	ON	ON	OFF

★ Note : If Cyrix 6x86 is being used, please check the CPU Date Code after 605.

★ Note :JP3 1-2 OFF,

JP3 1-2 ON For use Cyrix/IBM 6x86-150MHz-PR200+ , Cyrix/IBM 6x86L-

PR200+ , Cyrix/IBM 6x86MX-PR200 (75\*2) , Cyrix/IBM 6x86MX-PR233 (75\*2.5)  
CPUS.

1. Pentium<sup>®</sup> Processor 90 MHz

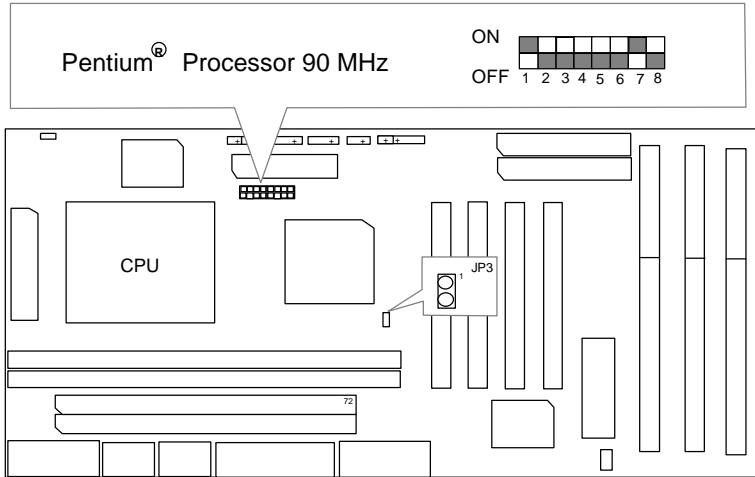

2. Pentium<sup>®</sup> Processor 100 MHz

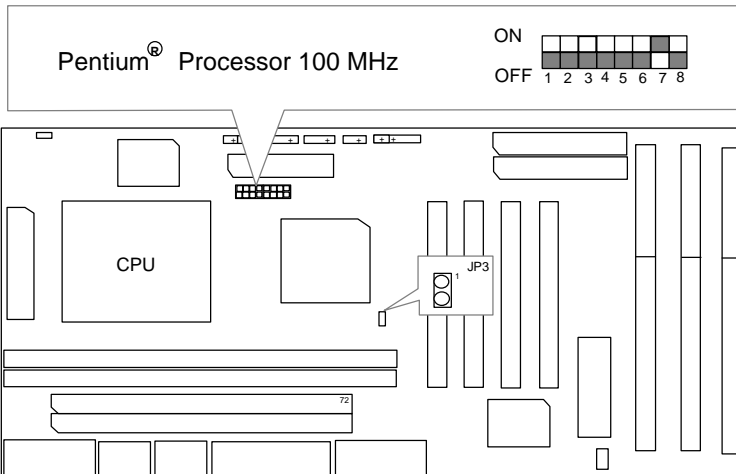

3. Pentium<sup>®</sup> Processor 120 MHz

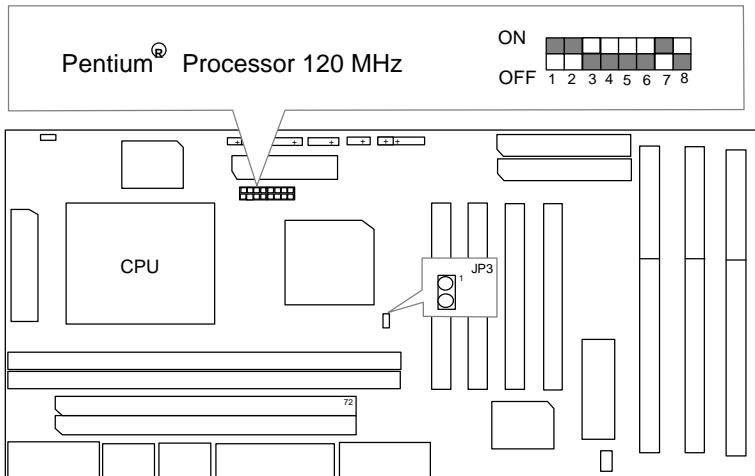

4. Pentium<sup>®</sup> Processor 133 MHz

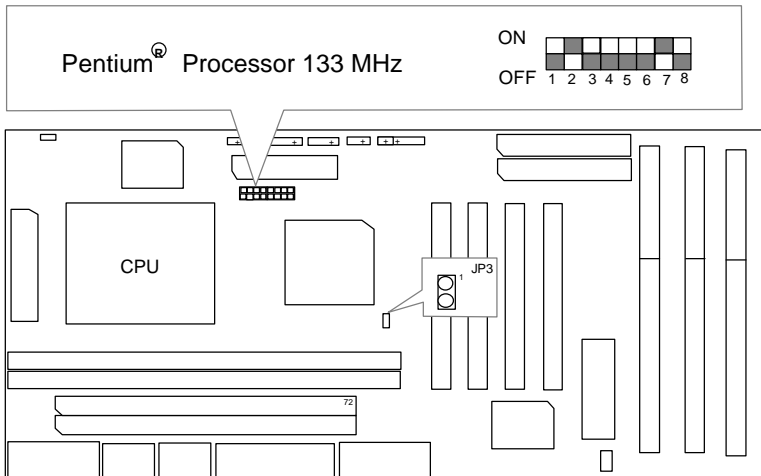

5. Pentium® Processor 150 MHz

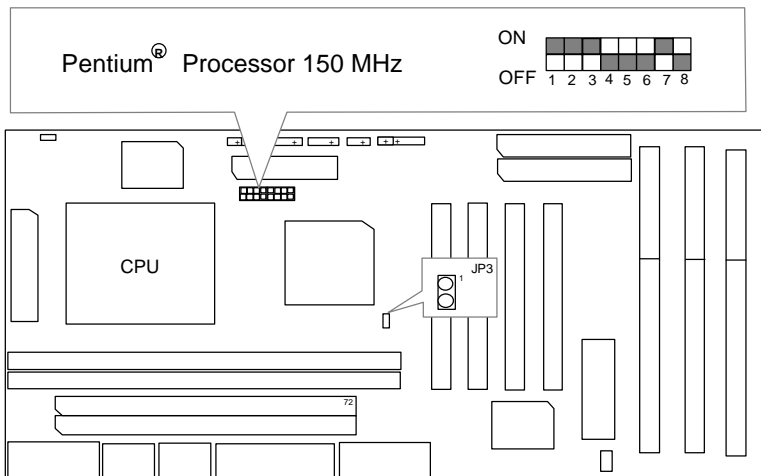

6. Pentium® Processor 166 MHz

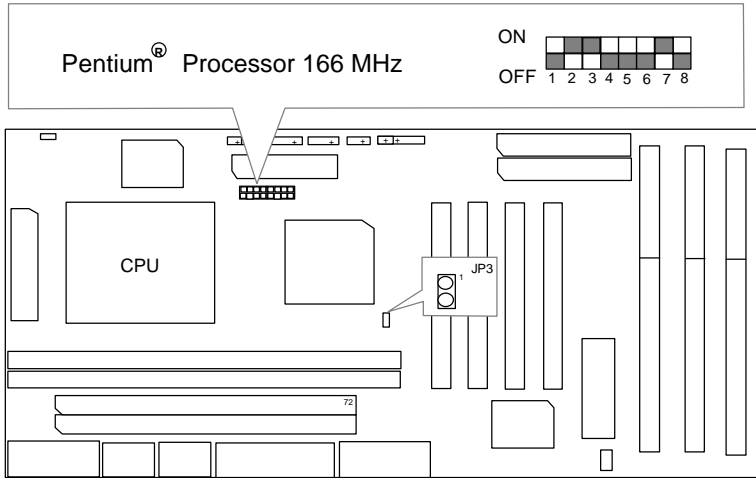

7. Pentium® Processor 180 MHz

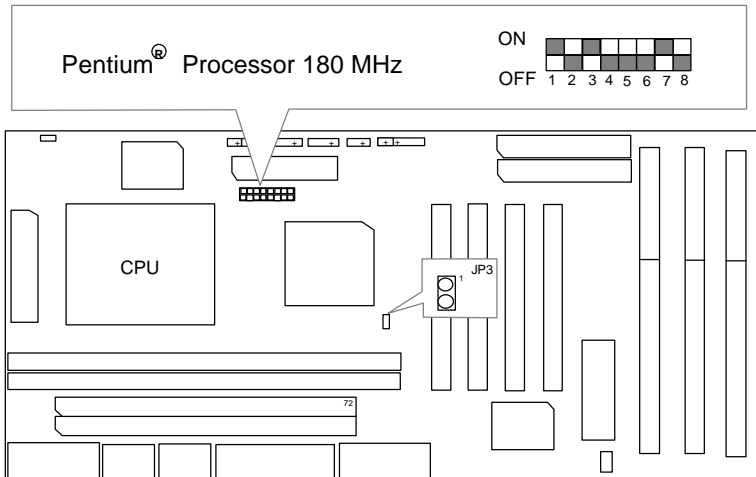

8. Pentium® Processor 200 MHz

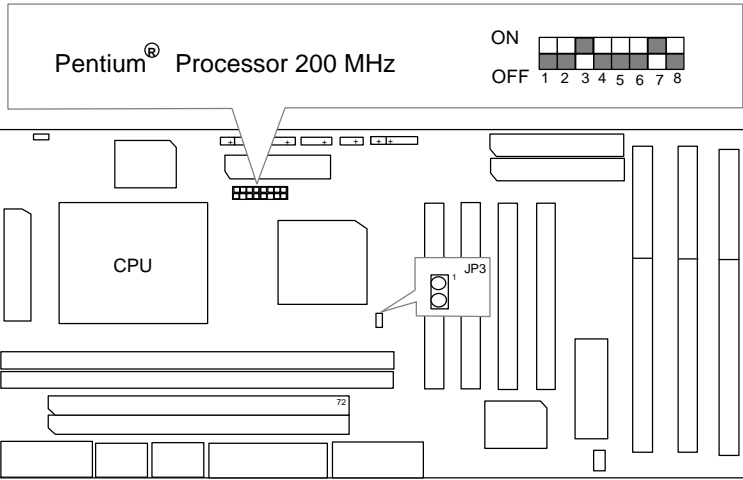

9. Intel MMX-150 MHz

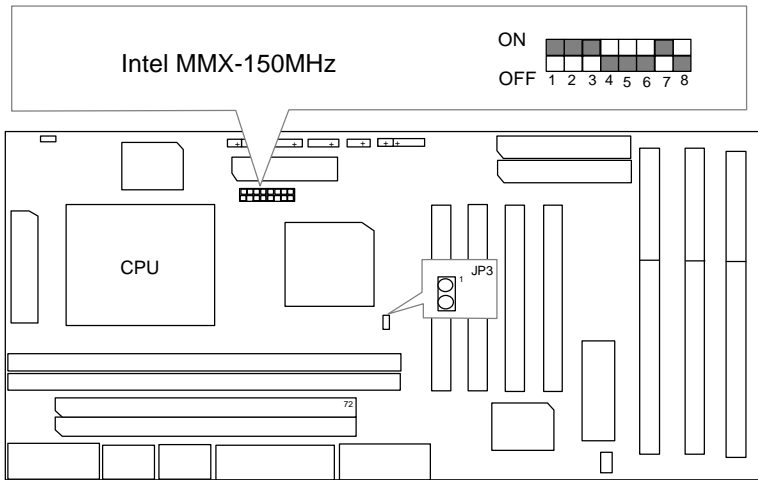

10. Intel MMX-166 MHz



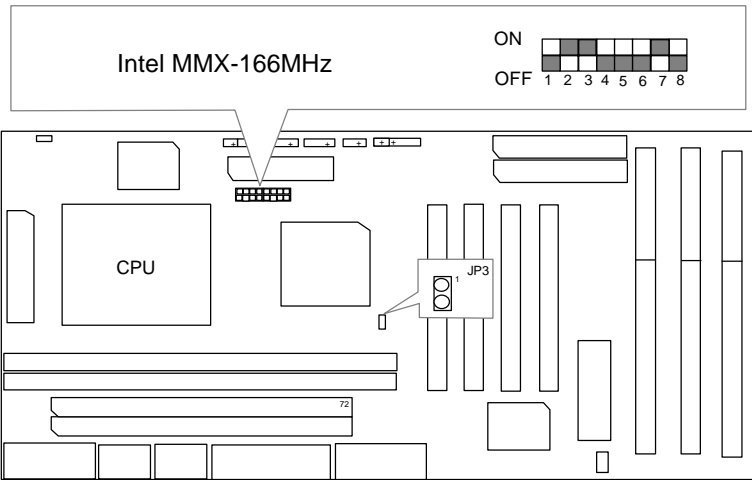

11. Intel MMX-200 MHz

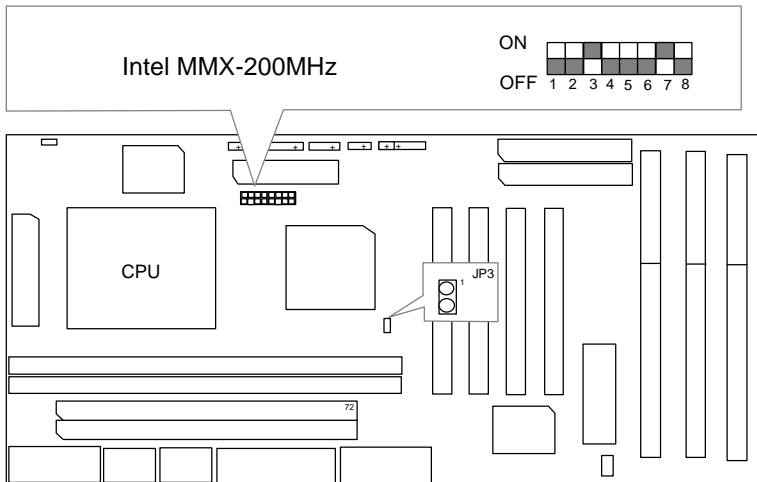

12. Intel MMX-233 MHz

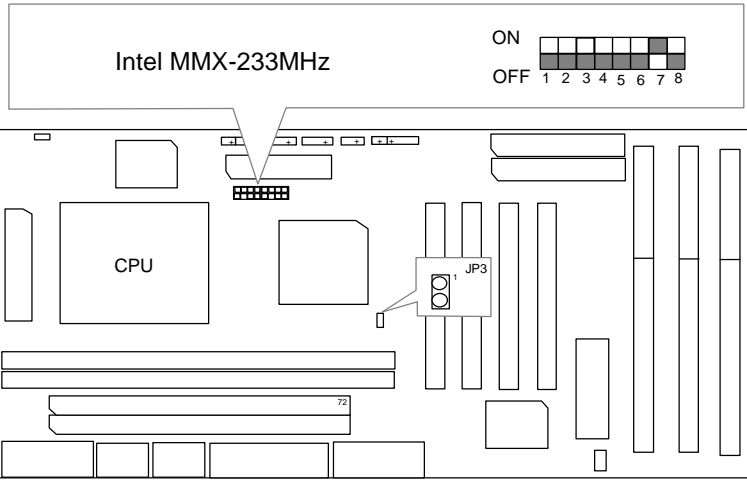

13. P54CT-150 MHz

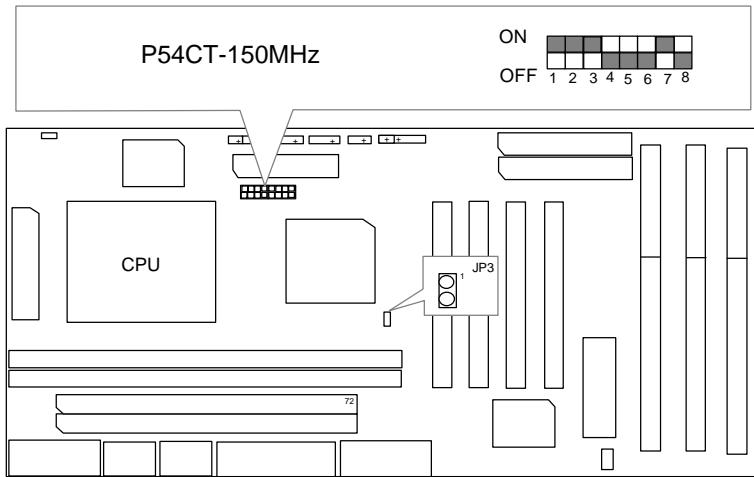

14. P54CT-166 MHz

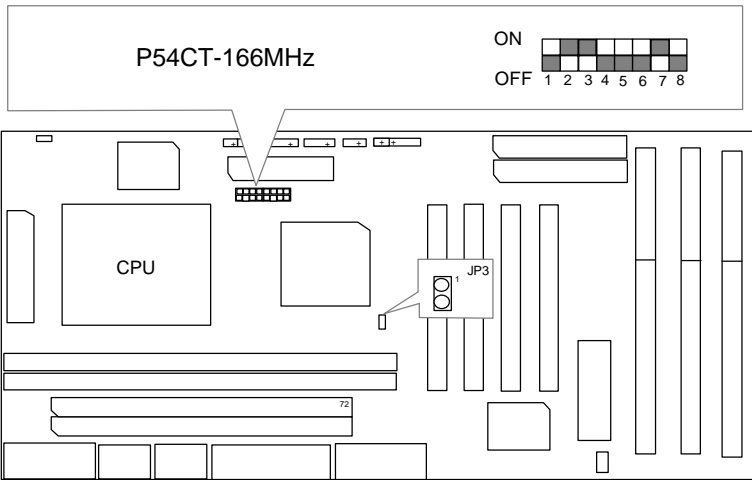

15. P54CTB-150 MHz

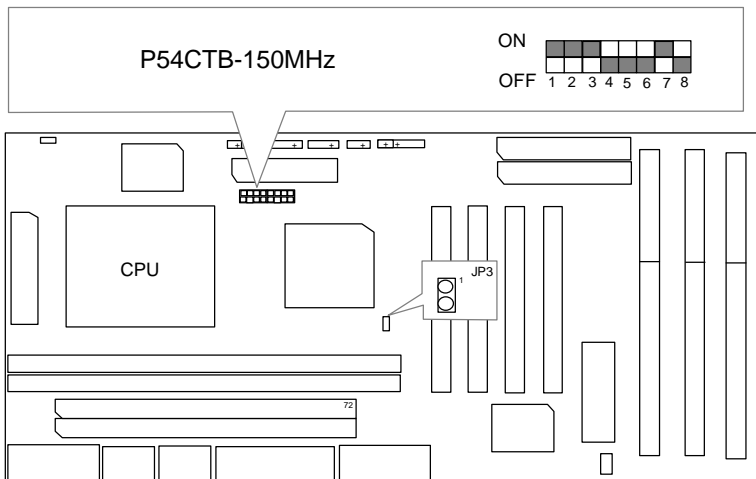

16. P54CTB-166 MHz

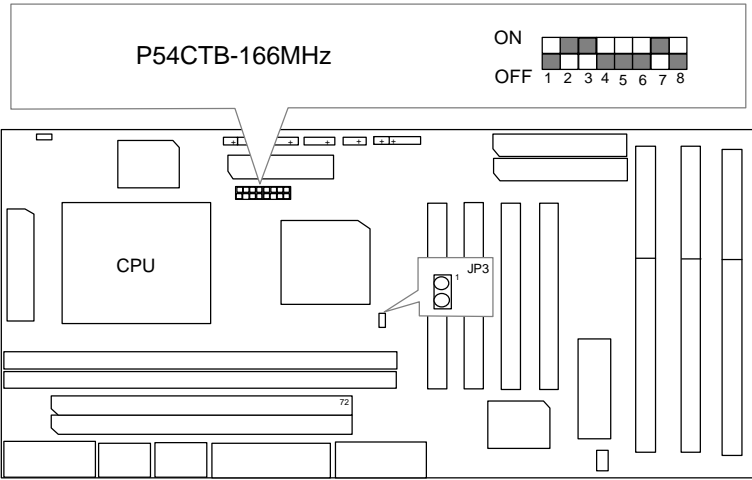

17. P54CTB-180 MHz

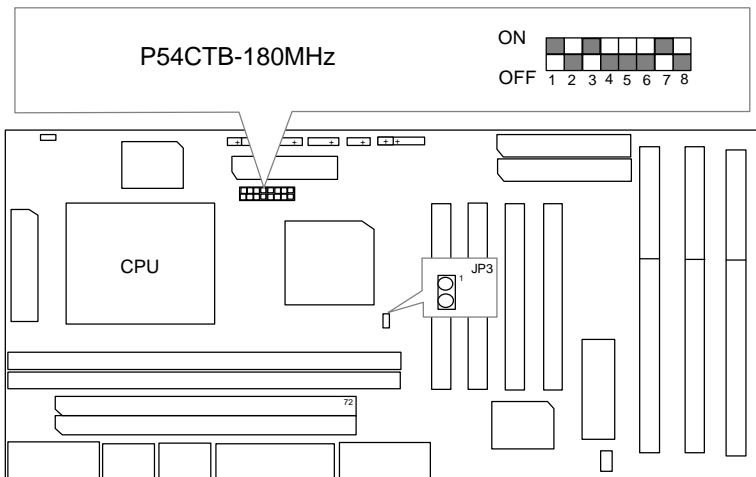

18. P54CTB-200 MHz

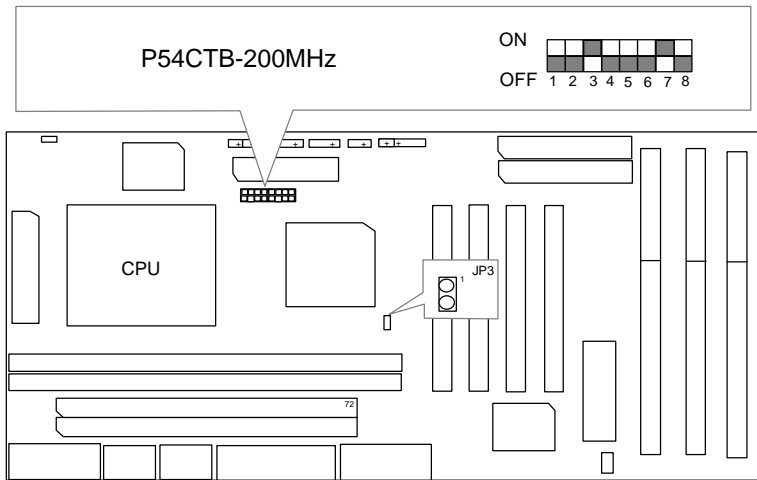

19. AMDK5-PR133

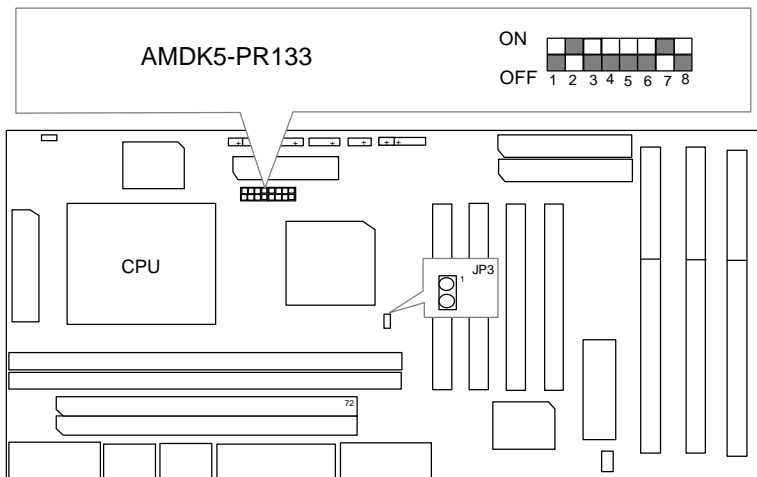

20. AMDK5-PR166

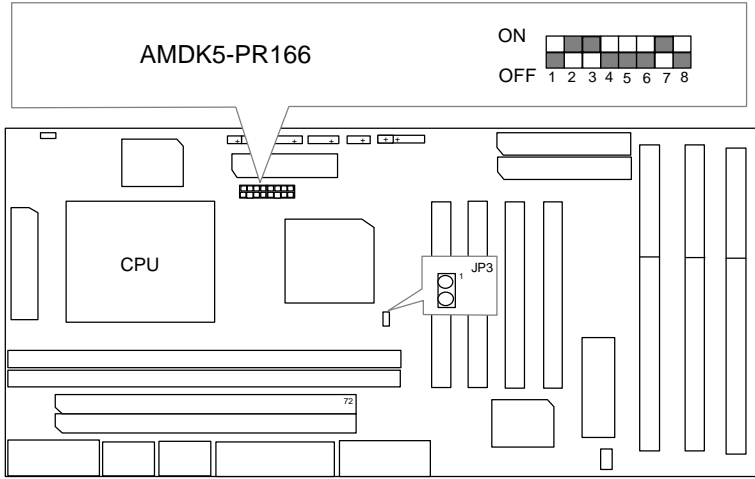

21. AMD-K6/166 (2.9V)

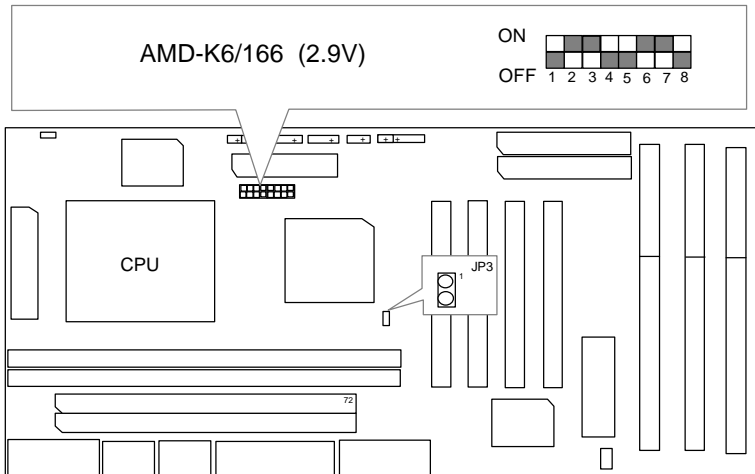

22. AMD-K6/180 (2.9V)

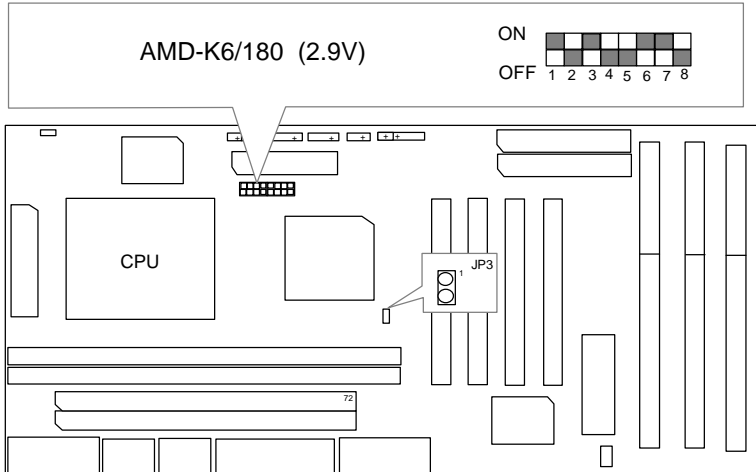

23. AMD-K6/200 (2.9V)

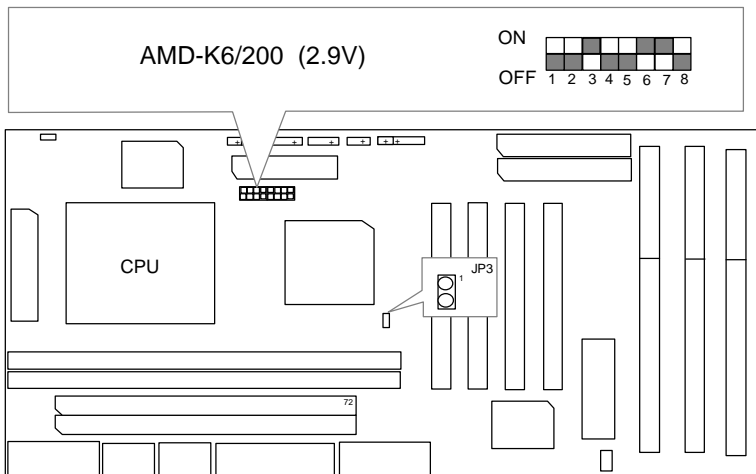

24. AMD-K6/233 (3.2V)

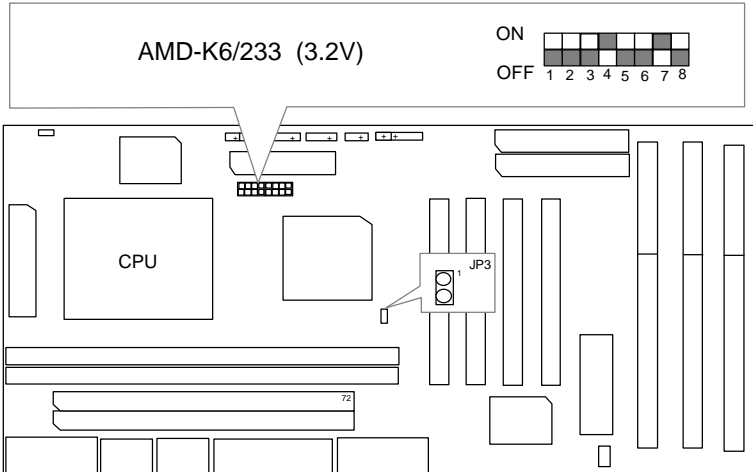

25. Cyrix / IBM 6x86-120 MHz-PR150+

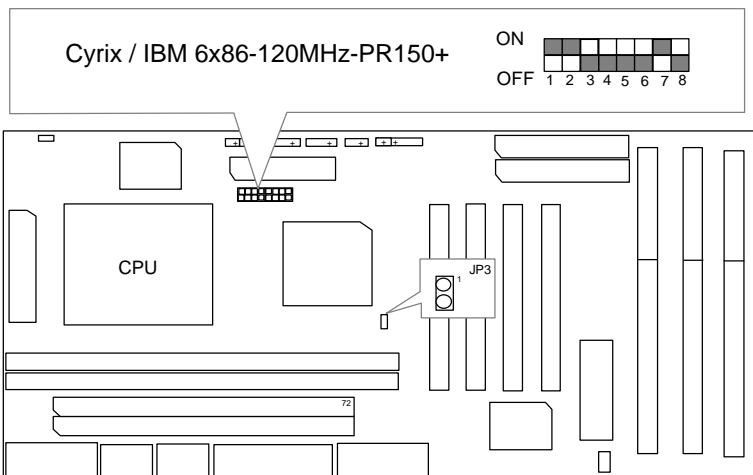



26. Cyrix /IBM 6x86-133 MHz-PR166+

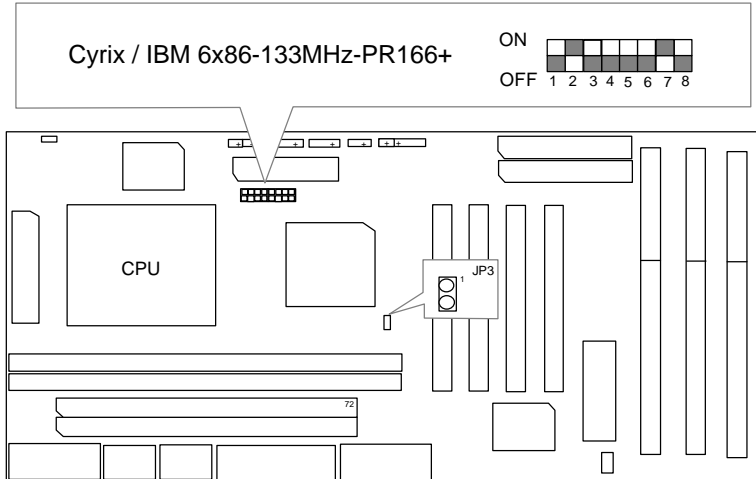

27. Cyrix /IBM 6x86-150 MHz-PR200+

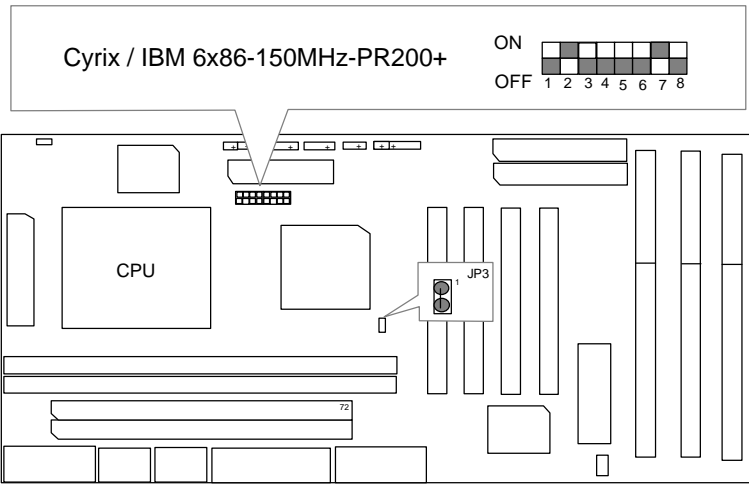

28. Cyrix / IBM 6x86L-PR150+ (2.8V)

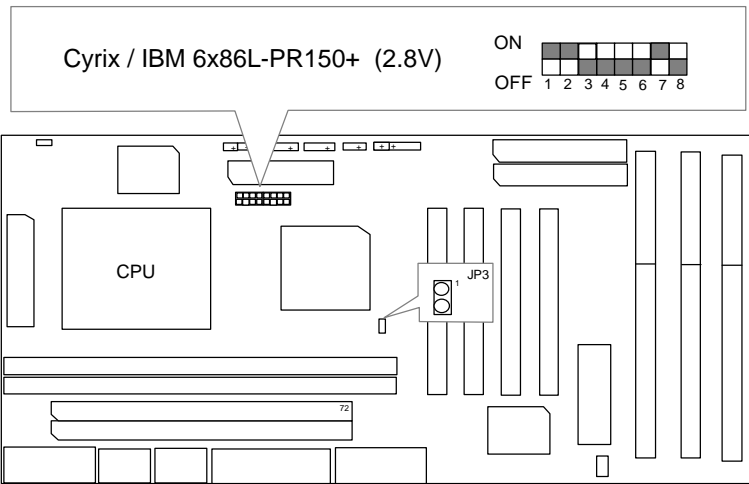

29. Cyrix / IBM 6x86L-PR166+ (2.8V)

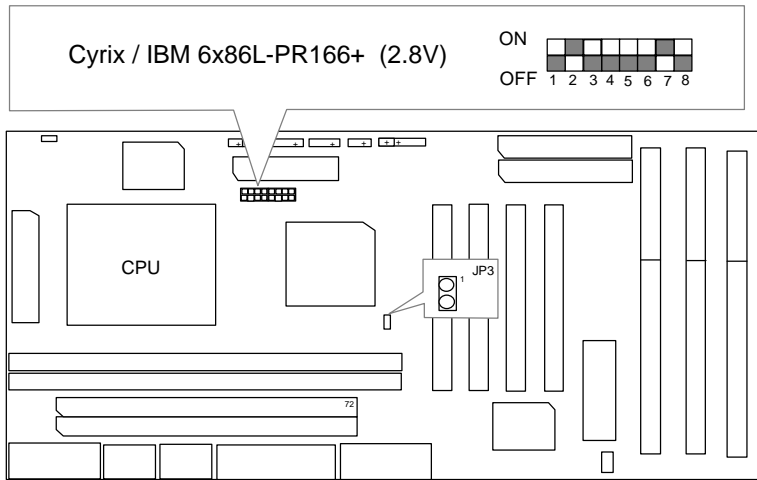

30. Cyrix / IBM 6x86L-PR200+ (2.8V)

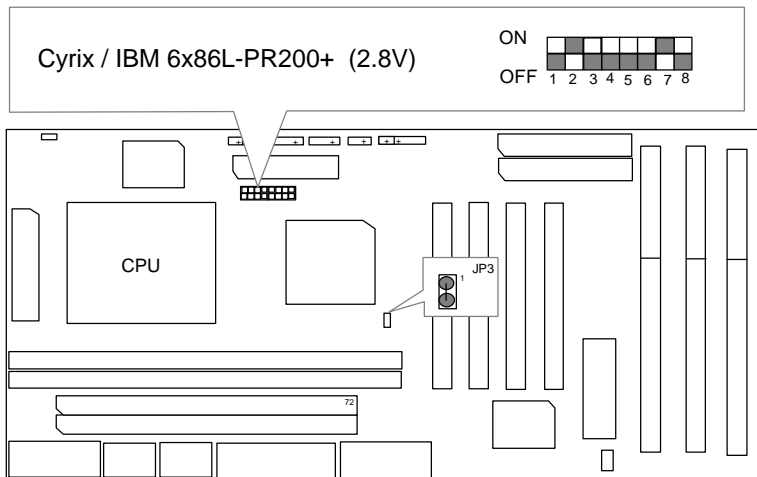

31. Cyrix / IBM 6x86MX-PR166 (60x2.5 2.9V)

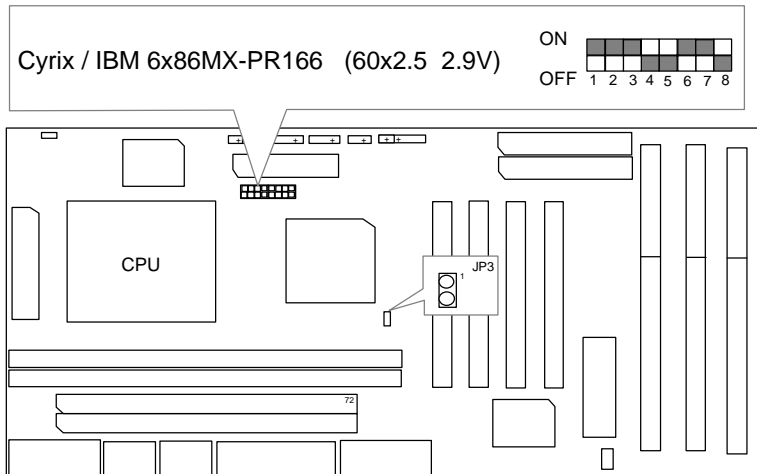

32. Cyrix / IBM 6x86MX-PR200 (66x2.5 2.9V)

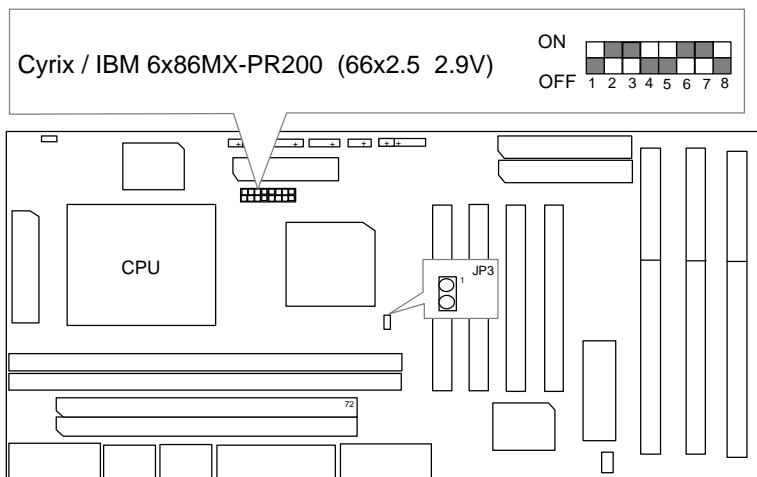

33. Cyrix / IBM 6x86MX-PR200 (75x2 2.9V)

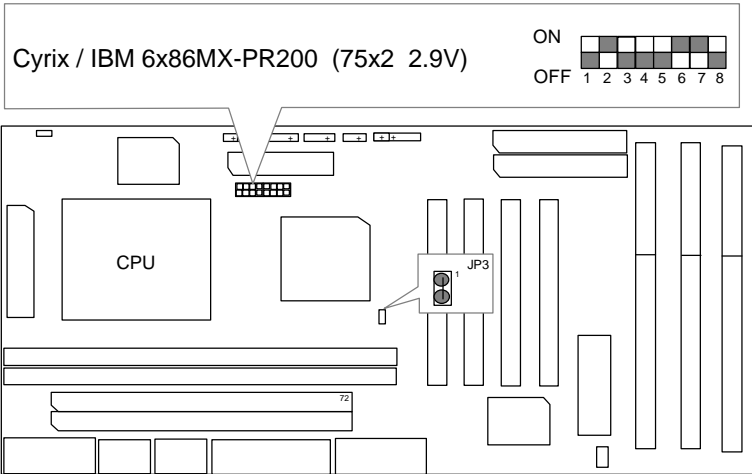

34. Cyrix / IBM 6x86MX-PR233 (66x3 2.9V)

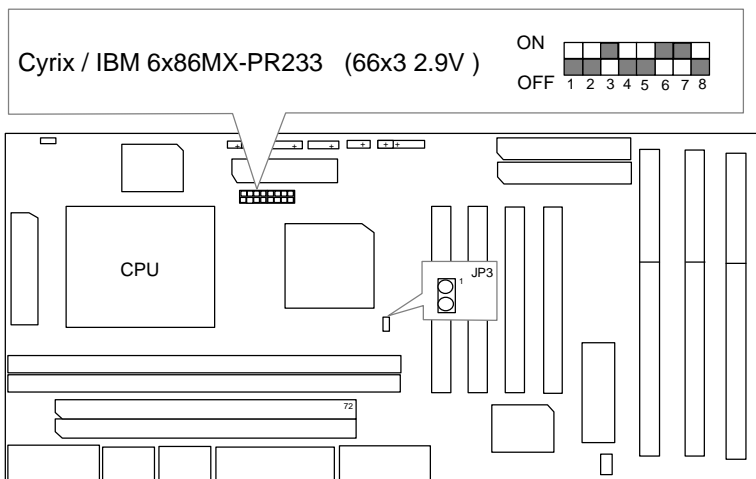

35. Cyrix / IBM 6x86MX-PR233 (75x2.5 2.9V)

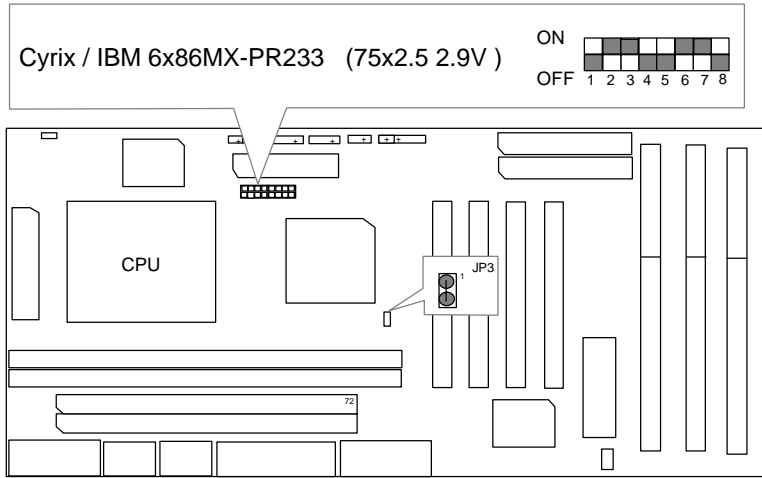

## II. Quick Installation Guide of Jumper setting:

SPK : Speaker Connector



Pin No.	Function
1	VCC
2	NC
3	NC
4	Data

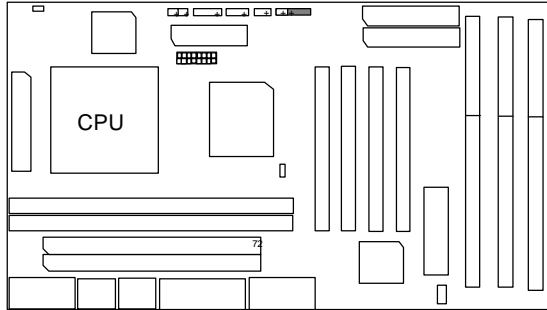

RST : Reset Switch

Open : 

Normal operation.

Close : 

For hardware reset system.

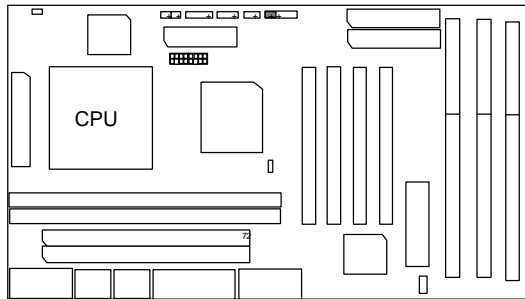

J10 : Power LED



Pin No.	Function
1	LED anode (+).
2	NC.
3	LED cathode (-).

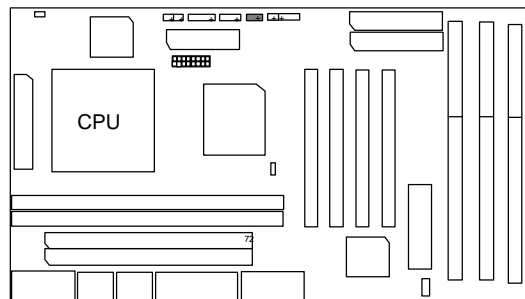

HD : IDE Hard Disk Active LED

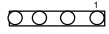

Pin No.	Function
1	LED anode (+)
2	LED cathode (-)
3	LED cathode (-)
4	LED anode (+)

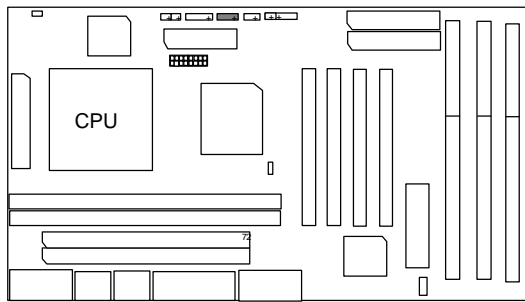

SOFTPW2 : Power On/Off Switch



Press first time to power on system .  
Second time to power off system.

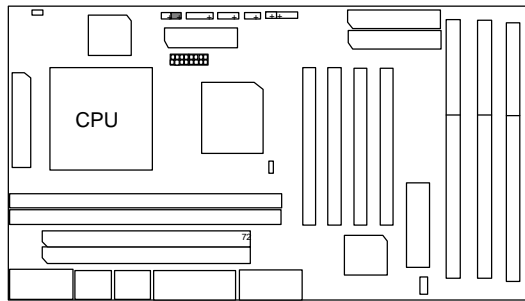

SOFTPW1 : Power Button



Press the button to enter green mode or hold the button for over 4 secs. to turn off the system.

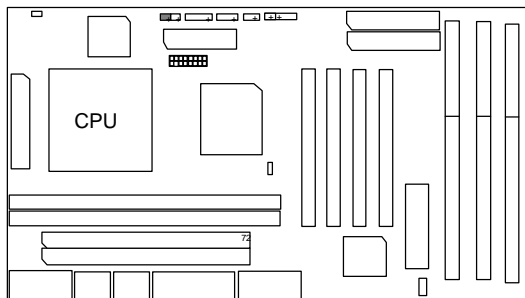



U1 : ATX Power Connector

Pin No.	Function
3,5,7,13,15-17	GND
4,6,19,20	VCC (+5V)
10	+12V
12	-12V
18	-5V
8	Power Good
9	5V SB (Stand by +5V)
14	PS-ON (Soft ON/OFF)

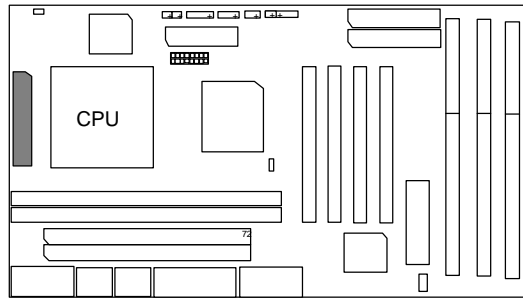

FAN1 : CPU Cooling Fan Power Connector



Pin No.	Function
1	+12V
2	NC

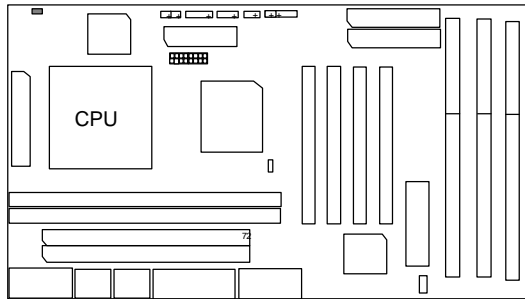

J13 : USB Port

Pin No.	Function
1	VCC
2	GND
3	SBD1-
4	SBD0+
5	SBD1+
6	SBD0-
7	GND
8	VCC

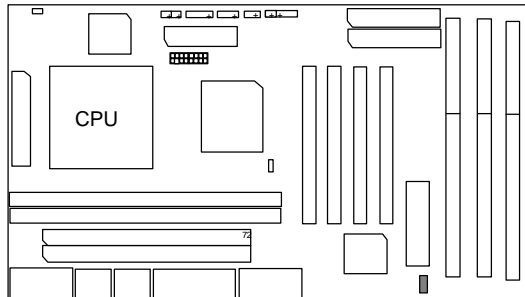

J3 : PS/2 Mouse



PS/2 Mouse	
Pin No.	Function
1	Key Data
2	NC
3	GND
4	VCC (+5V)
5	Key Clock.
6	NC

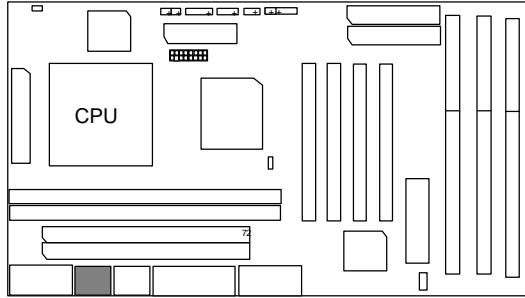

J4 : PS/2 Keyboard Connector



PS/2 Keyboard Connector	
Pin No.	Function
1	Key Data
2	NC
3	GND
4	VCC (+5V)
5	Key Clock.
6	NC

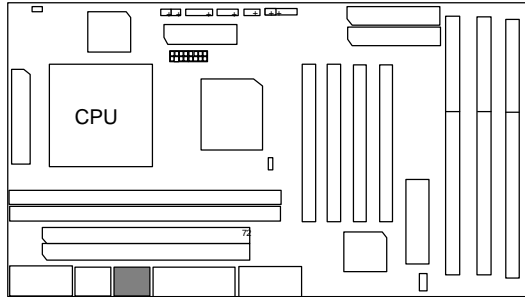

J1 : COM A

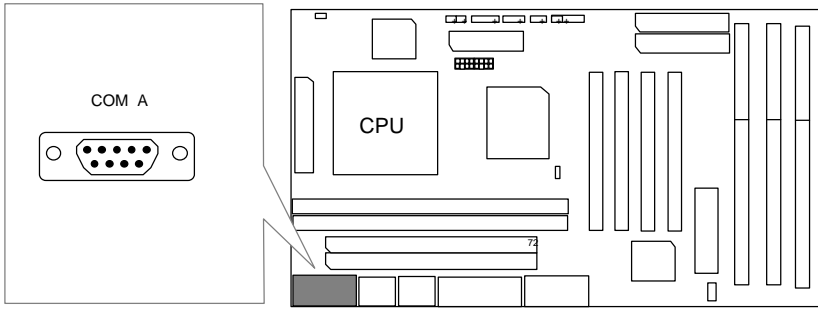

J9 : COM B

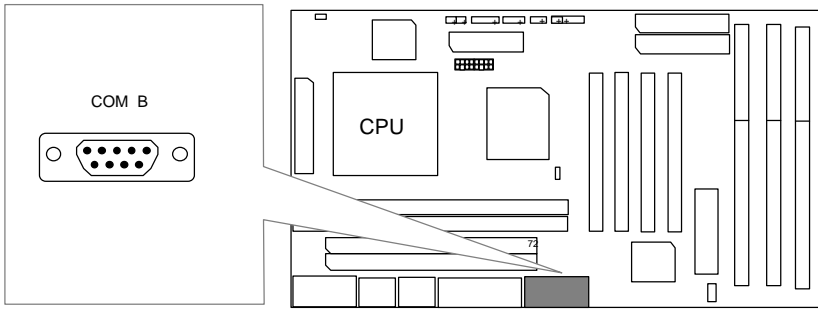

J8 : LPT PORT

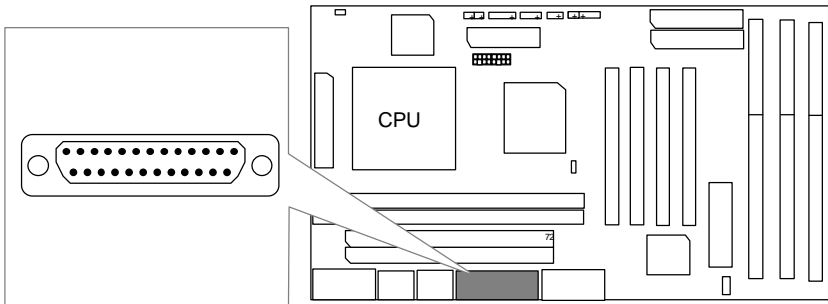

JP1 : FLOPPY PORT

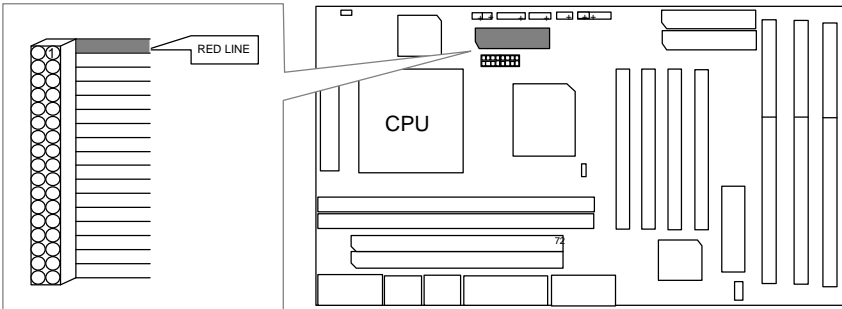



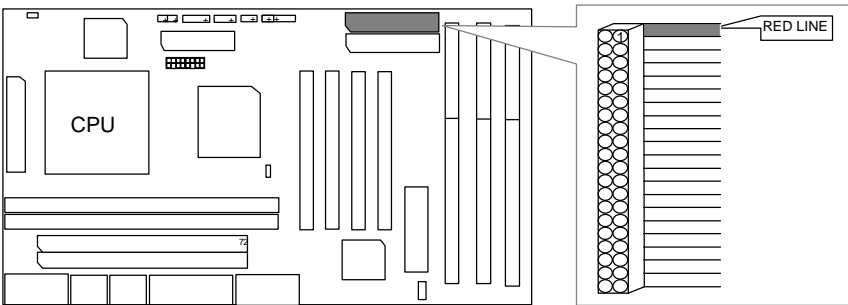



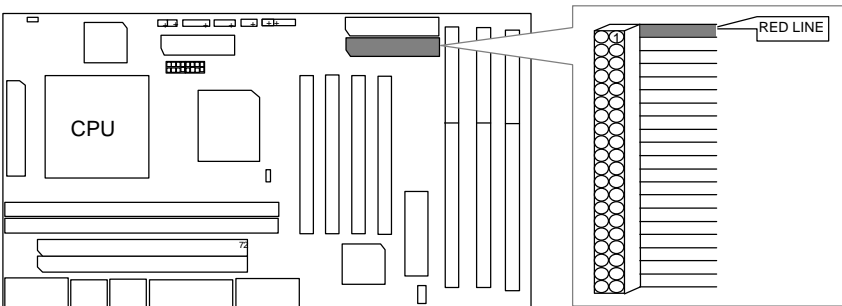











IDE1 : For Primary IDE port



IDE2 : For Secondary IDE port



SW : For CPU INT./EXT.FREQ.

Hz Speed	60 MHz	66 MHz
x 1.5	 OFF ON	 OFF ON
x 2	 OFF ON	 OFF ON
x 2.5	 OFF ON	 OFF ON
x 3	 OFF ON	 OFF ON
x 3.5	 OFF ON	 OFF ON
x 4	 OFF ON	 OFF ON
x 4.5	 OFF ON	 OFF ON
x 5	 OFF ON	 OFF ON
x 5.5	 OFF ON	 OFF ON

SW	4	5	6	7
AUTO	X	X	X	O
2.0 V	X	X	X	X
2.1 V	X	X	O	X
2.2 V	X	O	X	X
2.3 V	X	O	O	X
2.4 V	O	X	X	X
2.5 V	O	X	O	X
2.6 V	O	O	X	X
2.7 V	O	O	O	X
2.8 V	X	X	X	O
2.9 V	X	X	O	O
3.0 V	X	O	X	O
3.1 V	X	O	O	O
3.2 V	O	X	X	O
3.3 V	O	X	O	O
3.4 V	O	O	X	O
3.5 V	O	O	O	O

X : OFF  
O : ON

\* AUTO VOLTAGE: INTEL, CYRIX, AMDK5

2.9V:AMD-K6/166/180/200  
3.2V:AMD-K6/233

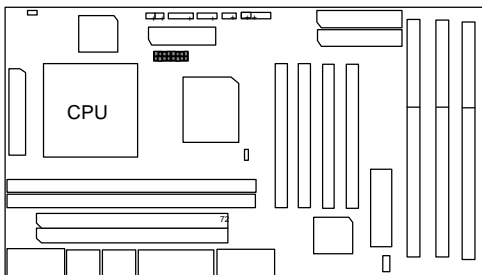

JP3	SW1	MHz
		60
CLOSE	ON	66
	OFF	66
	ON	83
	OFF	75

**III. Top Performance Test Setting:**

Users have to modify the values for each item in chipset features setup as the follow:

Note:60ns EDO DRAM is necessary for top performance setting.

Chipset features setup

ROM PCI / ISA BIOS  
 CHIPSET FEATURES SETUP  
 AWARD SOFTWARE, INC.

Auto Configuration	: Enabled	Refresh Cycle Time (us)	: 15.6
L2 (WB) Tag bit Length	: 8bit	RAS Pulse Width Refresh	: 6T
SRAM Back-to-Back	: Enabled	RAS Precharge Time	: 3T
NA# Enable	: Disabled	RAS to CAS Delay	: 3T
Starting Point of Paging	: 1T	CPU to PCI Post Write	: Disabled
CAS# Pulse Width (FP)	: 2T	ISA Bus Clock Frequency	: PCICLK/4
CAS# Pulse Width (EDO)	: 1T		
RAMW# Assertion Timing	: 3T		
CAS Precharge Time (FP)	: 1T/2T		
CAS Precharge Time (EDO)	: 1T/2T		
SDRAM CAS Latency	: 2T		
SDRAM WR Retire Rate	: X-1-1-1		
SDRAM Wait State Control	: 0WS		
Enhanced Memory Write	: Disabled		
Read Prefetch Memory RD	: Enabled		
CPU to PCI Burst Mem. WR	: Disabled		
MA Current Rating	: Low		
Video BIOS Cacheable	: Enabled		
Memory Hole at 15M-16M	: Disabled		
		ESC : Quit	↑ ↓ → ← : Select Item
		F1 : Help	PU/PD/+/- : Modify
		F5 : Old Values (Shift)	F2 : Color
		F6 : Load BIOS Defaults	
		F7 : Load Setup Defaults	

The author assumes no responsibility for any errors or omissions which may appear in this document nor does it make a commitment to update the information contained herein.

\*THIRD-PARTY BRANDS AND NAMES ARE THE PROPERTY OF THEIR RESPECTIVE OWNERS.

AUGUST 20, 1997 Taipei, Taiwan

---

**TABLE OF CONTENTS**

<b>1. INTRODUCTION.....</b>	<b>1-1</b>
1.1. PREFACE .....	1-1
1.2. KEY FEATURES .....	1-1
1.3. PERFORMANCE LIST .....	1-2
1.4. BLOCK DIAGRAM .....	1-3
1.5. INTRODUCE THE PCI - BUS .....	1-4
1.6. FEATURES .....	1-4
<b>2. SPECIFICATION .....</b>	<b>2-1</b>
2.1. HARDWARE .....	2-1
2.2. SOFTWARE .....	2-2
2.3. ENVIRONMENT .....	2-2
<b>3. HARDWARE INSTALLATION.....</b>	<b>3-1</b>
3.1. UNPACKING .....	3-1
3.2. MAINBOARD LAYOUT.....	3-2
3.3. QUICK REFERENCE FOR JUMPERS & CONNECTORS .....	3-2
3.4. DRAM INSTALLATION.....	3-6
3.5. SRAM INSTALLATION.....	3-9
Sync. SRAM (Pipeline Burst SRAM) .....	3-9
3.6. CPU INSTALLATION AND JUMPERS SETUP.....	3-9
3.7. CMOS RTC & ISA CFG CMOS SRAM.....	3-10
3.8. SPEAKER CONNECTOR INSTALLATION .....	3-10
3.9. POWER LED & KEY LOCK CONNECTOR INSTALLATION .....	3-10
3.10. HARDWARE RESET SWITCH CONNECTOR INSTALLATION .....	3-10
3.11. SOFTPW2 .....	3-10
3.12. SOFTPW1 .....	3-11
3.13. PERIPHERAL DEVICE INSTALLATION .....	3-11
3.14. KEYBOARD SETTING FUNCTION.....	3-11
<b>4. BIOS CONFIGURATION .....</b>	<b>4-1</b>
4.1. ENTERING SETUP .....	4-1
4.2. CONTROL KEYS .....	4-2
4.3. GETTING HELP .....	4-3



---

4.3.1. Main Menu.....	4-3
4.3.2. Status Page Setup Menu / Option Page Setup Menu .....	4-3
4.4. THE MAIN MENU.....	4-3
4.5. STANDARD CMOS SETUP MENU.....	4-5
4.6. BIOS FEATURES SETUP .....	4-10
4.7. CHIPSET FEATURES SETUP.....	4-14
4.8. POWER MANAGEMENT SETUP .....	4-19
4.9. PNP/PCI CONFIGURATION .....	4-22
4.10. LOAD BIOS DEFAULTS.....	4-23
4.11. LOAD SETUP DEFAULTS.....	4-24
4.12. INTEGRATED PERIPHERALS .....	4-25
4.13. SUPERVISOR / USER PASSWORD .....	4-30
4.14. IDE HDD AUTO DETECTION.....	4-31
4.15. SAVE & EXIT SETUP .....	4-32
4.16. EXIT WITHOUT SAVING.....	4-33
<b>5. AT TECHNICAL INFORMATION .....</b>	<b>5-1</b>
5.1. I/O BUS CONNECTOR PIN OUT .....	5-1
5.1.1. ISA SLOT PIN OUT .....	5-1
5.1.2. PCI - BUS SLOT PIN OUT .....	5-2
5.2. I/O & MEMORY MAP .....	5-3
5.3. TIMER & DMA CHANNELS MAP.....	5-3
5.4. INTERRUPT MAP .....	5-3
5.5. RTC & CMOS RAM MAP.....	5-5
APPENDIX A: POST MESSAGE .....	A-1
APPENDIX B: POST CODES.....	B-1
APPENDIX C: PROBLEM SHEET .....	C-1
APPENDIX D: FCC DOCUMENT .....	D-1



## 1. INTRODUCTION

### 1.1. PREFACE

Welcome to use the **GA-586STX** motherboard. The motherboard is a Pipeline 512 KB CACHE Pentium® Processor based PC/AT compatible system with ISA bus and PCI Local Bus, and has been designed to be the fastest PC / AT system. There are some new features allow you to operate the system with the performance you want.

This manual also explains how to install the motherboard for operation, and how to set up your CMOS CONFIGURATION with BIOS SETUP program.

### 1.2. KEY FEATURES

- ❑ Pentium® Processor based PC / AT compatible mainboard with PCI - ISA Bus.
- ❑ 4 PCI Bus slots, 3 ISA Bus slots.
- ❑ Supports Pentium® Processor running at 90-233 MHz, P54CT (150 / 166), MMX (150 / 166 / 200 / 233), P54CTB (150 / 166 / 180 / 200), AMDK5 (PR133 / PR166), AMD-K6(166/180/200 (2.9V) /233 (3.2V)), Cyrix / IBM 6x86-120/ 133/150(PR150+/PR166+/PR200+), Cyrix / IBM 6x86L (PR150+ / PR166+/PR200+(2.8V)), Cyrix / IBM 6x86MX (PR166 (60x2.5 2.9V) / PR200 (66x2.5 2.9V) (75x2 2.9V)/ PR233 (66x3 2.9V) (75x2.5 2.9V)).
- ❑ Supports true 64 bits CACHE and DRAM access mode.
- ❑ Supports 321 Pins (Socket 7) ZIF white socket on board.
- ❑ Supports 512 KB Pipeline Burst Sync. 2<sup>nd</sup> Level Cache.
- ❑ CPU L1 / L2 Write-Back cache operation.
- ❑ Supports 8 - 384 MB DRAM memory on board.
- ❑ Supports 2\*168 pin 64/72 Bit DIMM module.
- ❑ Supports 2-channel Ultra DMA/33 Enhanced PCI IDE ports for 4 IDE Devices.
- ❑ Supports 2\*COM (16550), 1\*LPT (EPP / ECP), 1\*1.44MB Floppy port.
- ❑ Supports PS/2 Keyboard & PS/2 Mouse port.
- ❑ Supports Green function, Plug & Play function.
- ❑ Licensed AWARD BIOS, FLASH EEPROM for BIOS update.
- ❑ 17cm\*30.3cm, ATX Form Factory.

□ Supports USB port.

### 1.3. PERFORMANCE LIST

The following list of performance data is the testing results of some popular benchmark testing programs.

These data are just for user's references referred by users, and there is no responsibility for different testing data values gotten by users. (The different Hardware & Software configuration will result in different benchmark testing results.)

- CPU Pentium® Processor Intel MMX-200 / 200 MHz, Cyrix 6x86L-PR200/6x86MX-PR200
- DRAM DIMM, SDRAM 32 MB \* 1 pc Total 32 MB LGS (GM72V16821BT10K)
- CACHE SIZE 512KB 2<sup>nd</sup> Level Cache on board.
- DISPLAY S3 Trio64V2/DX
- STORAGE Onboard IDE port + Quantum Fireball ST4320AT (Ultra DMA/33)
- O.S. Windows95 with Display Driver at 1024 x 768 x 256 colors & SiS IDE Driver Ver.1.37

◀Windows 95>-With S3 Trio64V2/DX Display Driver 1024\*768\*256  
-With SiS IDE Driver Ver.1.37

Program	Item	MMX200 MHz	6x86MX-PR200	200MHz	6x86L-PR200
Business	Database	4.52	4.84	4.05	4.14
Business	Publishing	4.92	4.94	4.47	4.56
Business	WP/SS	4.27	4.41	3.88	3.94
Business	Winstone 97	44.7	46.1	40.6	41.2
High End	Winstone 97	18.9	18.9	17.2	16.5

## 1.4. BLOCK DIAGRAM

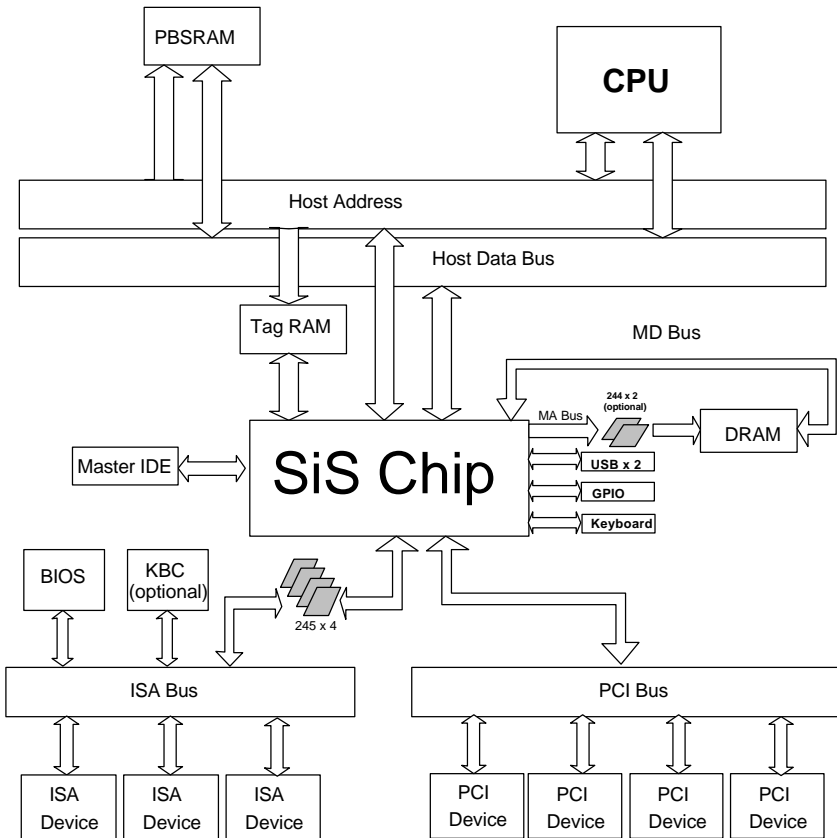

## 1.5. INTRODUCE THE PCI - BUS

Connecting devices to a CPU local bus can dramatically increase the speed of I/O-bound peripherals with only a slight increase in cost over traditional systems.

This price / Performance point has created a vast market potential for local bus products.

The main barrier to this market has been the lack of an accepted standard for local bus peripherals.

Many mainboard and chipset manufactures developed their own local bus implementations, but they are incompatible with each other.

The VL (Video Electronics Standards Association) local bus and PCI (Peripheral Component Interconnect) bus specification was created to end this confusion.

The PCI - bus standard, under development since Jun. 1992, which is designed to bring workstation-level performance to standard PC platform. The PCI - bus removes many of the bottlenecks that have hampered PC for several years.

On the PCI - bus, peripherals operate at the native speed of the computer system, thus enabling data transfer between peripherals and the system at maximum speed.

This performance is critical for bandwidth-constrained devices such as video, multimedia, mass storage, and networking adapters.

PCI - bus standard provides end-users with a low-cost, extendible and portable local bus design, which will allow system and peripherals from different manufactures to work together.

## 1.6. FEATURES

- 32 bits bus transfer mode.
- Bus Master or Slave access.
- Memory burst transfer to 132 MB/sec.
- 33 MHz operation speed.
- 10 device loading ability.
- CPU independent.

---

## 2. SPECIFICATION

### 2.1. HARDWARE

- CPU
  - Pentium® Processor 90 - 233 MHz, MMX, P54CT, P54CTB, AMDK5(PR133 / PR166), AMD-K6 (166 / 180 / 200 (2.9V) / 233 (3.2V) ), Cyrix / IBM 6x86 ( PR150+ / PR166+ / PR200+), Cyrix / IBM 6x86L (PR150+/ PR166+/ PR200+( 2.8V)), Cyrix / IBM 6x86MX (PR166 (60x2.5 2.9V) / PR200 (66x2.5 2.9V) (75x2 2.9V)/ PR233 (66x3 2.9V) (75x2.5 2.9V)).
  - 321 pins (socket 7) ZIF white socket on board.
  - 3.52V / 2.0V-3.5V Dual Power Ready.
- COPROCESSOR
  - Included in Pentium® processor.
- SPEED
  - 60 / 66 / 75 MHz system speed.
  - 30 / 33 PCI-Bus speed.
  - 7.5 / 8 MHz AT bus speed.
- DRAM MEMORY
  - 1 bank 2 Sockets 72 pins SIMM module on board.
  - 2 banks 168 pins DIMM module socket on board.
  - Use 4 / 8 / 16 / 32 / 64 /128 MB 60~70 ns SIMM module DRAM.
  - 8 ~ 384 MB DRAM size.
  - Supports Fast Page / EDO DRAM access mode.
- CACHE MEMORY
  - 16 / 24 / 32 / 64KB L1cache included in CPU.
  - 512 KB 2<sup>nd</sup> Level cache on board.
  - Supports Write Back cache function for both CPU & on board cache.
- I/O BUS SLOTS
  - 4 Master / Slave PCI-BUS Slots.
  - 3 16 bits ISA BUS Slots.

- IDE PORTS
  - 2-channel Ultra DMA/33 Enhanced IDE port on board.(Using IRQ14,15)
  - Supports Mode 3,4 IDE & ATAPI CD – ROM.
- I/O PORTS
  - Supports 2 16550 COM ports. (Using IRQ4, 3)
  - Supports 1 EPP/ECP LPT port. (Using IRQ7 or 5 and DMA3 or 1)
  - Supports 1 1.44/2.88 MB Floppy port. (Using DMA2 & IRQ6)
  - Supports PS/2 Mouse. (Using IRQ12 )
- GREEN FUNCTION
  - Standby & Suspend mode support.
  - Green switch & LED support.
  - IDE & Display power down support.
  - Monitor all IRQ / DMA / Display / I/O events.
- BIOS
  - 128KB FLASH EEPROM.
  - Supports Plug & Play Function.
- DIMENSION
  - ATX Form Factor, 4 layers PCB.

## 2.2. SOFTWARE

- BIOS
  - Licensed AWARD BIOS.
  - AT CMOS Setup, BIOS / Chipset Setup, Green Setup, Hard Disk Utility included.
- O.S.
  - Operation with MS-DOS®, Windows®95, WINDOWS™ NT, OS/2, NOVELL and SCO UNIX.

## 2.3. ENVIRONMENT

- Ambient Temp.
  - 0°C to +50°C (Operating).
- Relative Hum.
  - 0 to +85% (Operating).
- Altitude
  - 0 to 10,000 feet (Operating).
- Vibration
  - 0 to 1,000 Hz.
- Electricity
  - 4.9 V to 5.2 V.
  - Max. 20A current at 5V.



### 3. HARDWARE INSTALLATION

#### 3.1. UNPACKING

The mainboard package should contain the following:

- The **GA-586STX** mainboard.
- USER'S MANUAL for mainboard.
- Cable set for IDE & Floppy .

The mainboard contains sensitive electric components which can be easily damaged by static electricity, so the mainboard should be left in its original packing until it is installed.

Unpacking and installation should be done on a grounded anti-static mat.

The operator should be wearing an anti static wristband, grounded at the same point as the anti-static mat.

Inspect the mainboard carton for obvious damage. Shipping and handling may cause damage to your board. Be sure there are no shipping and handling damage on the board before proceeding.

After opening the mainboard carton, extract the system board and place it only on a grounded anti-static surface component side up. Again inspect the board for damage.

Press down on all of the socket IC's to make sure that they are properly seated. Do this only on with the board placed on a firm flat surface.

**⚠ DO NOT APPLY POWER TO THE BOARD IF IT HAS BEEN DAMAGED.**

You are now ready to install your mainboard. The mounting hole pattern on the mainboard matches the IBM-AT system board.

It is assumed that the chassis is designed for a standard IBM XT/AT mainboard mounting. Place the chassis on the anti-static mat and remove the cover.

Take the plastic clips, Nylon stand-off and screws for mounting the system board, and keep them separate.

### 3.2. MAINBOARD LAYOUT

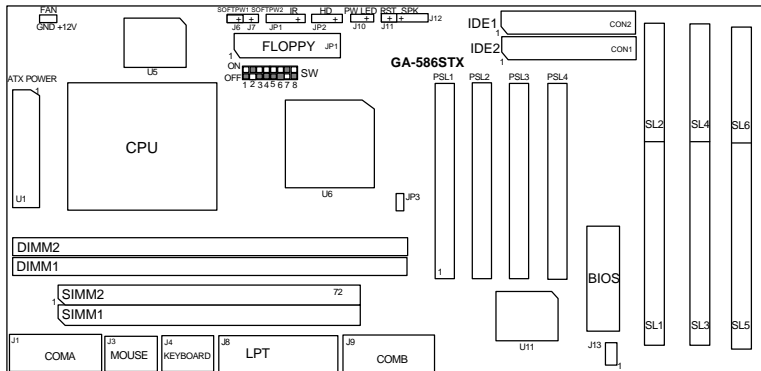

<Figure 3.1>

### 3.3. QUICK REFERENCE FOR JUMPERS & CONNECTORS

◆ J1,8,9,JP1,CON1,CON2 I/O Ports Connector	
J1	For Serial port1(COM A).
J9	For Serial port2 (COM B).
J8	For LPT port.
JP1	For Floppy port.
CON1	For Secondary IDE port.
CON2	For Primary IDE port.

◆ JP2 : Hard Disk active LED	
Pin No.	Function
1	LED anode(+).
2	LED cathode(-).
3	LED cathode(-).
4	LED anode(+).

---

◆ J7 : SOFTPW2	
Function	
Press first time to power on system. Second time to power off system.	

◆ J11 : Reset Switch (RST)	
Pin No.	Function
Open	For normal operation.
Close	For hardware reset system.

◆ J10 : Power LED	
Pin No.	Function
1	LED anode (+).
2	NC.
3	LED cathode (-).

◆ J12: Speaker Connector	
Pin No.	Function
1	VCC.
2	NC.
3	NC.
4	Data.

◆ J3,4 : PS/2 Mouse / Keyboard Connector	
Pin No.	Function
1	Key Data.
2	NC.
3	GND.
4	VCC (+5V).
5	Key Clock.
6	NC.

◆ FAN : CPU Cooling FAN Power Connector	
Pin No.	Function
1	+12V.
2	NC.

◆ J6 : SoftPW1 Connector	
Function	
Press this button to enter Green mode or hold the button for over 4 secs. To turn off the system.	

◆ Power: ATX POWER Connector	
Pin No.	Function
3,5,7,13,15-17	GND.
4,6,19,20	VCC (+5V).
10	+12V.
12	-12V.
18	-5V.
8	Power Good.
9	5V SB (Stand by +5V).
14	PS-ON (Soft ON/OFF).

◆ J13 : USB Port	
Pin No.	Function
1	VCC.
2	GND.
3	SBD1-.
4	SBD0+.
5	SBD1+.
6	SBD0-.
7	GND.
8	VCC.

◆ SW: CPU INT./ EXT. FREQ. RATIO

X	OFF
O	ON

SW 1	MHz
ON	60
OFF	66

SW	2	3	8
x 1.5	X	X	X
x 2	O	X	X
x 2.5	O	O	X
x 3	X	O	X
x 3.5	X	X	X
x 4	O	X	O
x 4.5	O	O	O
x 5	X	O	O
x 5.5	X	X	O

SW	4	5	6	7
AUTO	X	X	X	O
2.0 V	X	X	X	X
2.1 V	X	X	O	X
2.2 V	X	O	X	X
2.3 V	X	O	O	X
2.4 V	O	X	X	X
2.5 V	O	X	O	X
2.6 V	O	O	X	X
2.7 V	O	O	O	X
2.8 V	X	X	X	O
2.9 V	X	X	O	O
3.0 V	X	O	X	O
3.1 V	X	O	O	O
3.2 V	O	X	X	O
3.3 V	O	X	O	O
3.4 V	O	O	X	O
3.5 V	O	O	O	O

JP3	CLOSE	SW1	MHz
		ON	60
		OFF	66
	CLOSE	SW1	MHz
		ON	83
		OFF	75

### 3.4. DRAM INSTALLATION

The mainboard can be installed with 4 / 8 / 16 / 32 MB 72 pins SIMM module DRAM, and the DRAM speed must be 60 or 70 ns.

The DRAM, SDRAM memory system on mainboard consists of SIMM1/2 & DIMM1& DIMM2. Each bank consists of 2 sockets for 72 pins SIMM module DRAM and 2 DIMM Sockets. (Because of the 72 pins SIMM module is 32 bits width, using 2pcs which can match a 64 bits system ).

The total memory size is 8 - 384 MB.

For the DRAM installation position, please refer to Figure 3.1. Note that the Pin 1 of SIMM module must match with the Pin 1 of SIMM socket when the DRAM SIMM module is installed.

Insert the DRAM SIMM module into the SIMM socket at 45 degree angle.

If there is a wrong direction of Pin 1, the DRAM SIMM module couldn't be inserted into socket completely.

After completely insert SIMM module into socket, then press the SIMM module in vertical direction until the left and right metal holders can keep the SIMM module standing up firmly.

DRAM configuration table:

SIMM 1/2	DIMM1	DIMM2	TOTAL
4MB * 2pcs.			8MB
	8MB		8MB
8MB * 2pcs.			16MB
	16MB		16MB
	8MB	8MB	16MB
4MB * 2pcs.	8MB	8MB	24MB
	8MB	16MB	24MB
8MB * 2pcs.	8MB		24MB
	16MB	16MB	32MB

SIMM 1/2	DIMM1	DIMM2	TOTAL
4MB * 2pcs.	8MB	16MB	32MB
8MB * 2pcs.	8MB	8MB	32MB
16MB * 2pcs.			32MB
	32MB		32MB
8MB * 2pcs.	16MB		32MB
4MB * 2pcs.	32MB		40MB
4MB * 2pcs.	16MB	16MB	40MB
8MB * 2pcs.	8MB	16MB	40MB
	8MB	32MB	40MB
16MB * 2pcs.	8MB		40MB
	16MB	32MB	48MB
4MB * 2pcs.	8MB	32MB	48MB
8MB * 2pcs.	16MB	16MB	48MB
16MB * 2pcs.	8MB	8MB	48MB
8MB * 2pcs.	32MB		48MB
16MB * 2pcs.	16MB		48MB
4MB * 2pcs.	16MB	32MB	56MB
8MB * 2pcs.	8MB	32MB	56MB
16MB * 2pcs.	16MB	8MB	56MB
	32MB	32MB	64MB
8MB * 2pcs.	16MB	32MB	64MB
16MB * 2pcs.	16MB	16MB	64MB
32MB * 2pcs.			64MB
	64MB		64MB
16MB * 2pcs.	32MB		64MB
32MB * 2pcs.	8MB		72MB
4MB * 2pcs.	32MB	32MB	72MB
16MB * 2pcs.	8MB	32MB	72MB
	8MB	64MB	72MB

SIMM 1/2	DIMM1	DIMM2	TOTAL
	16MB	64MB	80MB
8MB * 2pcs.	32MB	32MB	80MB
16MB * 2pcs.	16MB	32MB	80MB
32MB * 2pcs.	8MB	8MB	80MB
32MB * 2pcs.	16MB		80MB
32MB * 2pcs.	8MB	16MB	88MB
	32MB	64MB	96MB
16MB * 2pcs.	32MB	32MB	96MB
32MB * 2pcs.	16MB	16MB	96MB
32MB * 2pcs.	32MB		96MB
32MB * 2pcs.	8MB	32MB	104MB
32MB * 2pcs.	16MB	32MB	112MB
64MB * 2pcs.			128MB
32MB * 2pcs.	32MB	32MB	128MB
	64MB	64MB	128MB
64MB * 2pcs.	8MB		136MB
64MB * 2pcs.	16MB		144MB
64MB * 2pcs.	8MB	8MB	144MB
64MB * 2pcs.	8MB	16MB	152MB
64MB * 2pcs.	16MB	16MB	160MB
64MB * 2pcs.	32MB		160MB
64MB * 2pcs.	8MB	32MB	168MB
64MB * 2pcs.	16MB	32MB	176MB
64MB * 2pcs.	32MB	32MB	192MB
64MB * 2pcs.	64MB	8MB	200MB
64MB * 2pcs.	64MB	16MB	208MB
64MB * 2pcs.	64MB	32MB	224MB
64MB * 2pcs.	64MB	64MB	256MB
128MB * 2pcs.	8MB	8MB	272MB



SIMM 1/2	DIMM1	DIMM2	TOTAL
128MB * 2pcs.	8MB	16MB	280MB
128MB * 2pcs.	16MB	16MB	288MB
128MB * 2pcs.	8MB	32MB	296MB
128MB * 2pcs.	16MB	32MB	304MB
128MB * 2pcs.	32MB	32MB	320MB
128MB * 2pcs.	8MB	64MB	328MB
128MB * 2pcs.	16MB	64MB	336MB
128MB * 2pcs.	32MB	64MB	352MB
128MB * 2pcs.	64MB	64MB	384MB

### 3.5. SRAM INSTALLATION

#### ***Sync. SRAM (Pipeline Burst SRAM)***

If Sync SRAM Chip is installed, it consists of Pipeline Burst 1 Pc 64 K x 64 512KByte.

**There is no jumper for cache size setting.**

### 3.6. CPU INSTALLATION AND JUMPERS SETUP

The system speed depends on the frequency of CLOCK GENERATOR. The user can change SW selection to set up the system speed to 60 or 66 or 75 MHz for 3.3V/2.5V Pentium<sup>®</sup> Processor (90-233 MHz) / AMDK5(PR133 / PR166) / AMD-K6(166/180/200(2.9V)/233(3.2V)), Cyrix / IBM 6x86 (PR150+ / PR166+ / PR200+), Cyrix / IBM 6x86L (PR150+/PR166+/PR200+ (2.8V)), Cyrix / IBM 6x86MX (PR166 (60x2.5 2.9V) / PR200 (66x2.5 2.9V) (75x2 2.9V)/ PR233 (66x3 2.9V) (75x2.5 2.9V)).

The mainboard can use Pentium<sup>®</sup> Processor, P54CT, MMX or P54CTB, AMDK5, AMD-K6, Cyrix / IBM 6x86, CPU, and the CPU speed must match with the frequency of CLOCK GEN. It will cause system hanging up if the CLOCK GEN.'S frequency is faster than CPU's.

- The CPU is a sensitive electric component and it can be easily damaged by static electricity, so users must keep it away from metal surface when the CPU is installed onto mainboard.
- When the user installs the CPU on socket, please notice that the PIN 1 of CPU is in the same corner as the PIN 1 of socket!
- Before the CPU is installed, the mainboard must be placed on a flat plane in order to avoid being broken by the pressure of CPU installation.

### 3.7. CMOS RTC & ISA CFG CMOS SRAM

Built-in Real Time Clock (RTC) With 256B CMOS SRAM in SiS5582.

### 3.8. SPEAKER CONNECTOR INSTALLATION

There is always a speaker in AT system for sound purpose. The 4-Pins connector **SPK** is used to connect speaker. The speaker can work well in both direction of connector when it is installed to the **SPK** connector of mainboard.

### 3.9. POWER LED & KEY LOCK CONNECTOR INSTALLATION

There is a system power LED light and a key on the panel of case. The power LED will light on when system is powered-on, and the key can lock or unlock the keyboard input, both are connected to a 5 PIN connector. The connector should be installed to **PWR** of mainboard in correct direction.

### 3.10. HARDWARE RESET SWITCH CONNECTOR INSTALLATION

The RESET switch on panel provides users with HARDWARE RESET function which is almost the same as power-on/off. The system will do a cold start after the RESET switch is pushed and released by user. The RESET switch is a 2 PIN connector and should be installed to the **RST** jumper of the mainboard.

### 3.11. SOFTPW2

Press first time to power on system. Second time to power off system.

### 3.12. SOFTPW1

Press the button to enter green mode or hold the button for over 4 secs. to turn off the system.

### 3.13. PERIPHERAL DEVICE INSTALLATION

After installation of the device and setup of the jumpers, the mainboard can be mounted into the case and fixed by screw. To complete the mainboard installation, the peripheral devices could be installed now. The basic system needs a display interface card and a storage device.

If a PCI - Bus device is to be installed in the system, any one of four PCI - Bus slots can be used for Slave or Master PCI - Bus device.

After installing the peripheral device, the user should check everything again and prepare to power-on the system.

### 3.14. KEYBOARD SETTING FUNCTION

After booting the O.S., there are some special functions used by keyboard as follows:

"CTRL_ALT_DEL"	– Pressing these keys simultaneously will cause system to Warm Start (Software Reset).
----------------	--



## 4. BIOS CONFIGURATION

Award's BIOS ROM has a built-in Setup program that allows users to modify the basic system configuration.

This type of information is stored in battery-backed CMOS SRAM so that it retains the Setup information when the power is turned off.

### 4.1. ENTERING SETUP

Power ON the computer and press <Del> immediately will allow you to enter Setup.

The other way to enter Setup is to power on the computer, when the below message appears briefly at the bottom of the screen during the POST (Power On Self Test), press <Del> Key or simultaneously press <Ctrl>, <Alt>, and <Esc> keys.

- **TO ENTER SETUP BEFORE BOOT PRESS CTRL-ALT-ESC OR DEL KEY**

If the message disappears before you respond and you still wish to enter Setup, restart the system to try again by turning it OFF then ON or pressing the "RESET" button on the system case.

You may also restart by simultaneously press <Ctrl>, <Alt>, and <Del> keys.

If you do not press the keys at the correct time and the system does not boot, an error message will be displayed and you will again be asked to,

- **PRESS F1 TO CONTINUE, CTRL-ALT-ESC OR DEL TO ENTER SETUP**

## 4.2. CONTROL KEYS

Up arrow	Move to previous item.
Down arrow	Move to next item.
Left arrow	Move to the item in the left hand.
Right arrow	Move to the item in the right hand.
Esc key	Main Menu - Quit and not save changes into CMOS Status Page Setup Menu and Option Page Setup Menu - Exit current page and return to Main Menu.
PgUp key	Increase the numeric value or make changes.
PgDn key	Decrease the numeric value or make changes.
F1 key	General help, only for Status Page Setup Menu and Option Page Setup Menu.
F2 key	Change color from total 16 colors.
F3 key	Calendar, only for Status Page Setup Menu.
F4 key	Reserved.
F5 key	Restore the previous CMOS value from CMOS, only for Option Page Setup Menu.
F6 key	Load the default CMOS value from BIOS default table, only for Option Page Setup Menu.
F7 key	Load the default.
F8 key	Reserved.
F9 key	Reserved.
F10 key	Save all the CMOS changes, only for Main Menu.

### 4.3. GETTING HELP

#### 4.3.1. Main Menu

The on-line description of the highlighted setup function is displayed at the bottom of the screen.

#### 4.3.2. Status Page Setup Menu / Option Page Setup Menu

Press F1 to pop up a small help window that describes the appropriate keys to use and the possible selections for the highlighted item. To exit the Help Window press <Esc>.

### 4.4. THE MAIN MENU

Once you enter Award BIOS CMOS Setup Utility, the Main Menu (Figure 4.1) will appear on the screen.

The Main Menu allows you to select from seven setup functions and two exit choices. Use arrow keys to select among the items and press <Enter> to accept or enter the sub-menu.

ROM PCI / ISA BIOS  
 CMOS SETUP UTILITY  
 AWARD SOFTWARE, INC.

STANDARD CMOS SETUP  BIOS FEATURES SETUP  CHIPSET FEATURES SETUP  POWER MANAGEMENT SETUP  PNP/PCI CONFIGURATION  LOAD BIOS DEFAULTS  LOAD SETUP DEFAULTS	INTEGRATED PERIPHERALS  SUPERVISOR PASSWORD  USER PASSWORD  IDE HDD AUTO DETECTION  SAVE & EXIT SETUP  EXIT WITHOUT SAVING
ESC : Quit F10 : Save & Exit Setup	
↑ ↓ → ← : Select Item (Shift)F2 : Change Color	
Time, Date, Hard Disk Type, ...	

Figure 4.1: Main Menu

- Standard CMOS setup  
This setup page includes all the items in a standard compatible BIOS.
- BIOS features setup  
This setup page includes all the items of Award special enhanced features.
- Chipset features setup  
This setup page includes all the items of chipset special features.
- Power management setup  
This setup page includes all the items of Green function features.
- PNP/PCI configuration  
This setup page includes all the items of PNP/PCI configuration features.
- Load BIOS defaults  
BIOS defaults indicates the most appropriate value of the system parameter which the system would be in safe configuration.
- Load setup defaults  
BIOS defaults indicates the most appropriate value of the system parameter which the system would be in safe configuration.
- Integrated Peripherals  
This setup page includes all the items of peripherals features.
- Supervisor Password  
Change, set, or disable password. It allows you to limit access to the system and Setup, or just to Setup.
- User Password  
Change, set, or disable password. It allows you to limit access to the system.
- IDE HDD auto detection



Automatically configure hard disk parameter.

- Save & exit setup  
Save CMOS value changes to CMOS and exit setup.
- Exit without save  
Abandon all CMOS value changes and exit setup.

#### 4.5. STANDARD CMOS SETUP MENU

The items in Standard CMOS Setup Menu (Figure 4.2) are divided into 9 categories. Each category includes no, one or more than one setup items. Use the arrows to highlight the item and then use the <PgUp> or <PgDn> keys to select the value you want in each item.

ROM PCI / ISA BIOS  
STANDARD CMOS SETUP  
AWARD SOFTWARE, INC.

Date (mm:dd:yy): Wed, Jan 22 1997  
Time (hh:mm:ss): 11 : 08 : 12

HARD DISKS	TYPE	SIZE	CYLS	HEAD	PRECOMP	LANDZ	SECTOR	MODE
Primary Master	: Auto	0	0	0	0	0	0	Auto
Primary Slave	: None	0	0	0	0	0	0	-----
Secondary Master	: None	0	0	0	0	0	0	-----
Secondary Slave	: None	0	0	0	0	0	0	-----

Driver A : 1.44 , 3.5 in  
Driver B : None  
Floppy 3 Mode Support : Disabled

Base Memory: 640 K  
Extended Memory: 31744 K  
Other Memory: 384 K  

---

Total Memory: 32768 K

Video : EGA/VGA  
Halt On : No Errors

---

ESC : Quit                    ↑ ↓ → ← : Select Item                    PU/PD/+/- : Modify  
F1 : Help                    (Shift)F2 : Change Color

Figure 4.2: Standard CMOS Setup Menu

- Date

The date format is <day>, <date> <month> <year>. Press <F3> to show the calendar.

day	The day, from Sun to Sat, determined by the BIOS and is display-only
date	The date, from 1 to 31 (or the maximum allowed in the month)
month	The month, Jan. through Dec.
year	The year, from 1900 through 2099

- Time

The time format in <hour> <minute> <second>.

The time is calculated base on the 24-hour military-time clock.

For example, 1 p.m. is 13:00:00.

- Primary HDDs / Secondary HDDs

The category identify the types of hard disk from drive C to drive F 4 devices that has been installed in the computer.

There are three options for definable type; User, Auto and None .

Type User is user-definable; and type Auto means automatically detecting HDD's type and None means No IDE HDD installed.

If you select Type User, related information is asked to be entered to the following items.

Enter the information directly from the keyboard and press <Enter>.

Those information should be provided in the documentation from your hard disk vendor or the system manufacturer.

CYLS.	number of cylinders
HEADS	number of heads
PRECOMP	write precomp
LANDZONE	landing zone
SECTORS	number of sectors

If a hard disk has not been installed select NONE and press <Enter>.

- Drive A type / Drive B type

The category identify the types of floppy disk drive A or drive B that has been installed in the computer.

None	No floppy drive installed
360K, 5.25 in.	5-1/4 inch PC-type standard drive; 360 kilobyte capacity.
1.2M, 5.25 in.	5-1/4 inch AT-type high-density drive; 1.2 megabyte capacity (3-1/2 inch when 3 Mode is Enabled).
720K, 3.5 in.	3-1/2 inch double-sided drive; 720 kilobyte capacity
1.44M, 3.5 in.	3-1/2 inch double-sided drive; 1.44 megabyte capacity.
2.88M, 3.5 in.	3-1/2 inch double-sided drive; 2.88 megabyte capacity.

- Floppy 3 Mode Support (for Japan Area)

Disable	Normal Floppy Drive.
Drive A	Drive A is 3 mode Floppy Drive.
Drive B	Drive B is 3 mode Floppy Drive.

Both	Drive A & B are 3 mode Floppy Drive.
------	--------------------------------------

- Video

The category detects the type of adapter used for the primary system monitor that must match your video display card and monitor.

Although secondary monitors are supported, you do not have to select the type in setup.

EGA/VGA	Enhanced Graphics Adapter/Video Graphics Array. For EGA, VGA, SVGA, or PGA monitor adapters
CGA 40	Color Graphics Adapter, power up in 40 column mode
CGA 80	Color Graphics Adapter, power up in 80 column mode
MONO	Monochrome adapter, includes high resolution monochrome adapters

- Halt on

The category determines whether the computer will stop if an error is detected during power up.

NO errors	The system boot will not be stopped for any error that may be detected
All errors	Whenever the BIOS detects a non-fatal error, the system will be stopped and you will be prompted
All, But Keyboard	The system boot will not stop for a keyboard error; it will stop for all other errors
All, But Diskette	The system boot will not stop for a disk error; it will stop for all other errors

All, But Disk/Key	The system boot will not stop for a keyboard or disk error; it will stop for all other errors
-------------------	---

- Memory

The category is display-only which is determined by POST (Power On Self Test) of the BIOS.

**Base Memory**

The POST of the BIOS will determine the amount of base (or conventional) memory installed in the system.

The value of the base memory is typically 512 K for systems with 512 K memory installed on the motherboard, or 640 K for systems with 640 K or more memory installed on the motherboard.

**Extended Memory**

The BIOS determines how much extended memory is present during the POST.

This is the amount of memory located above 1 MB in the CPU's memory address map.

**Expanded Memory**

Expanded Memory is memory defined by the Lotus / Intel / Microsoft (LIM) standard as EMS.

Many standard DOS applications can not utilize memory above 640, the Expanded Memory Specification (EMS) swaps memory which not utilized by DOS with a section, or frame, so these applications can access all of the system memory.

Memory can be swapped by EMS is usually 64 within 1 MB or memory above 1 MB, depends on the chipset design.

Expanded memory device driver is required to use memory as Expanded Memory.

**Other Memory**

This refers to the memory located in the 640 to 1024 address space. This is memory that can be used for different applications.

DOS uses this area to load device drivers to keep as much base memory free for application programs. Most use for this area is Shadow RAM.

#### 4.6. BIOS FEATURES SETUP

ROM PCI / ISA BIOS BIOS FEATURES SETUP AWARD SOFTWARE, INC.			
Virus Warning	: Disabled	Video BIOS Shadow	: Enabled
CPU Internal Cache	: Enabled	C8000 - CBFFF Shadow	: Disabled
External Cache	: Enabled	CC000 - CFFFF Shadow	: Disabled
Quick Power On Self Test	: Enabled	D0000 - D3FFF Shadow	: Disabled
Boot Sequence	: A, C, SCSI	D4000 - D7FFF Shadow	: Disabled
Swap Floppy Drive	: Disabled	D8000 - DBFFF Shadow	: Disabled
Boot Up Floppy Seek	: Enabled	DC000 - DFFFF Shadow	: Disabled
Boot Up NumLock Status	: On		
Security Option	: Setup		
PCI/VGA Palette Snoop	: Disabled		
OS Select For DRAM >64MB	: Non-OS2		
ESC : Quit    ↑ ↓ → ← : Select Item F1 : Help      PU/PD/+- : Modify F5 : Old Values (Shift)F2 : Color F6 : Load BIOS Defaults F7 : Load Setup Defaults			

Figure 4.3: BIOS Features Setup

- Virus Warning

This category flashes on the screen. During and after the system boots up, any attempt to write to the boot sector or partition table of the hard disk drive will halt the system and the following error message will appear, in the mean time, you can run anti-virus program to locate the problem.

The default value is Disabled.

Enabled	Activate automatically when the system boots up causing a warning message to appear when anything attempts to access the boot sector or hard disk partition table.
---------	--

Disabled	No warning message appears when anything attempts to access the boot sector or hard disk partition table.
----------	---

- CPU Internal Cache / External Cache

These two categories speed up memory access. However, it depends on CPU / chipset design.

The default value is Enabled.

Enabled	Enable cache function.
Disabled	Disable cache function.

- Quick Power On Self Test

This category speeds up Power On Self Test (POST) after you power on the computer. If it set to Enable, BIOS will skip some check items during POST.

The default value is Enabled.

Enabled	Enable quick POST.
Disabled	Normal POST.

- Boot Sequence

This category determines which drive computer searches first for the disk operating system (i.e., DOS).

The default value is A,C,SCSI.

A,C,SCSI	System will first search for floppy disk drive then hard disk (C) drive and SCSI drive.
C,A,SCSI	System will first search for hard disk (C) drive then floppy disk drive and SCSI drive.
C,CDROM,A	System will first search for hard disk (C) drive then CDROM drive and floppy disk drive.
CDROM,C,A	System will first search for CDROM drive then hard disk (C) drive and floppy disk drive.
D,A,SCSI	System will first search for hard disk (D) drive then floppy disk drive and SCSI drive.

E,A,SCSI	System will first search for hard disk (E) drive then floppy disk drive and SCSI drive.
F,A,SCSI	System will first search for hard disk (F) drive then floppy disk drive and SCSI drive.
SCSI,A,C	System will first search for SCSI drive then floppy disk drive and hard disk (C) drive .
SCSI,C,A	System will first search for SCSI drive and hard disk (C) drive then floppy disk drive .
C only	System will only search for hard disk (C) drive.
LS/ZIP,C	System will first search for floppy disk drive (LS) or ZIP drive then hard disk (C) drive.

- Swap Floppy Drive

The default value is Disabled.

Enabled	Floppy A & B will be swapped under DOS.
Disabled	Floppy A & B will be normal definition.

- Boot Up Floppy Seek

During POST, BIOS will determine if the floppy disk drive installed is 40 or 80 tracks. 360 type is 40 tracks while 720 , 1.2 and 1.44 are all 80 tracks.

The default value is Enabled.

Enabled	BIOS searches for floppy disk drive to determine if it is 40 or 80 tracks. Note that BIOS can not tell from 720, 1.2 or 1.44 drive type as they are all 80 tracks.
Disabled	BIOS will not search for the type of floppy disk drive by track number. Note that there will not be any warning message if the drive installed is 360 .

- Boot Up NumLock Status

The default value is On.



On	Keypad is number keys.
Off	Keypad is arrow keys.

- Security option

The default value is Setup.

Setup	The system will boot and access to Setup will be denied if the correct password is not entered at the prompt.
System	The system will not boot and access to Setup will be denied if the correct password is not entered at the prompt.

- **To disable security, select PASSWORD SETTING at Main Menu and then you will be asked to enter password. If the user does not type anything and just press <Enter>, it will disable security. Once the security is disabled, the system will boot and you can enter Setup freely.**

- PCI/VGA Palette Snoop

The default value are Disabled.

Enabled	For having Video Card on ISA Bus and VGA Card on PCI Bus.
Disabled	For VGA Card only.

- OS Select For DRAM>64MB

The default value is Non-OS2.

Non-OS2	Using non-OS2 operating system.
OS2	Using OS2 operating system and DRAM>64MB.

- Video BIOS Shadow

It determines whether video BIOS will copied to RAM, however, it is optional from chipset design. Video Shadow will increase the video speed.

The default value is Enable.

Enabled	Video shadow is enabled.
Disabled	Video shadow is disabled.

- C8000 - CFFFF Shadow / D0000 - DFFFF Shadow

These categories determine whether optional ROM will be copied to RAM by 16 byte. The default value are Disabled.

Enabled	Optional shadow is enabled.
Disabled	Optional shadow is disabled.

#### 4.7. CHIPSET FEATURES SETUP

ROM PCI / ISA BIOS  
 CHIPSET FEATURES SETUP  
 AWARD SOFTWARE, INC.

Auto Configuration	: Enabled	Refresh Cycle Time (us)	: 15.6
L2 (WB) Tag bit Length	: 8bit	RAS Pulse Width Refresh	: 6T
SRAM Back-to-Back	: Enabled	RAS Precharge Time	: 4T
NA# Enable	: Disabled	RAS to CAS Delay	: 4T
Starting Point of Paging	: 1T	CPU to PCI Post Write	: Disabled
CAS# Pulse Width (FP)	: 2T	ISA Bus Clock Frequency	: PCICLK/4
CAS# Pulse Width (EDO)	: 1T		
RAMW# Assertion Timing	: 3T		
CAS Precharge Time (FP)	: 1T/2T		
CAS Precharge Time (EDO)	: 1T/2T		
SDRAM CAS Latency	: 2T		
SDRAM WR Retire Rate	: X-1-1-1		
SDRAM Wait State Control	: 1WS		
Enhanced Memory Write	: Disabled		
Read Prefetch Memory RD	: Enabled	ESC : Quit	↑ ↓ → ← : Select Item
CPU to PCI Burst Mem. WR	: Disabled	F1 : Help	PU/PD/+/- : Modify
MA Current Rating	: Low	F5 : Old Values (Shift)	F2 : Color
Video BIOS Cacheable	: Enabled	F6 : Load BIOS Defaults	
Memory Hole at 15M-16M	: Disabled	F7 : Load Setup Defaults	

Figure 4.4: Chipset Features Setup

- Auto Configuration

The default value is Enabled

Enabled	Enabled Auto Configuration
Disabled	Disabled Auto Configuration.

- L2 (WB) Tag bit Length

The default value is 8bits

7bits	L2 (WB) Tag bit Length to 7 bits.
8bits	L2 (WB) Tag bit Length to 8 bits.

- SRAM Back-to-Back

The default value is Enabled

Enabled	Enabled SRAM Back-to-Back.
Disabled	Disabled SRAM Back-to-Back.

- NA# Enable

The default value is Disabled

Enabled	Enabled NA#.
Disabled	Disabled NA#.

- Starting Point of Paging

The default value is 1T

1T	Set starting Point of Paging to 1T.
2T	Set starting Point of Paging to 2T.
4T	Set starting Point of Paging to 4T.
8T	Set starting Point of Paging to 8T.

- CAS# Pulse Width (FP)

The default value is 2T

1T	CAS# Pulse Width (FP) to 1T.
2T	CAS# Pulse Width (FP) to 2T.

- CAS# Pulse Width (EDO)

The default value is 1T.

1T	CAS# Pulse Width (EDO) to 1T.
2T	CAS# Pulse Width (EDO) to 2T.

- RAMW# Assertion Timing

The default value is 3T

2T	RAMW# Assertion Timing to 2T.
3T	RAMW# Assertion Timing to 3T.

- CAS Precharge Time (FP)

The default value is 1T/2T

1T	CAS Precharge Time (FP) to 1T.
2T	CAS Precharge Time (FP) to 2T.
1T/2T	CAS Precharge Time (FP) to 1T/2T.

- CAS Precharge Time (EDO)

The default value is 1T/2T

1T	CAS Precharge Time (EDO) to 1T.
2T	CAS Precharge Time (EDO) to 2T.
1T/2T	CAS Precharge Time (EDO) to 1T/2T.

- SDRAM CAS Latency

The default value is 2T

2T	SDRAM CAS Latency to 2T.
3T	SDRAM CAS Latency to 3T.

- SDRAM WR Retire Rate

The default value is X-1-1-1.

X-1-1-1	SDRAM WR Retire Rate to X-1-1-1.
X-2-2-2	SDRAM WR Retire Rate to X-2-2-2.

- SDRAM Wait State Control

The default value is 1WS.

0 WS	SDRAM Wait State Control to 0WS.
1 WS	SDRAM Wait State Control to 1WS.

- Enhanced Memory Write

The default value is Disabled.

Enabled	Enabled Enhanced Memory Write .
Disabled	Disabled Enhanced Memory Write.

- Read Prefetch Memory RD

The default value is Enabled.

Enabled	Enabled Read Prefetch Memory RD.
Disabled	Disabled Read Prefetch Memory RD.

- CPU to PCI Burst Mem. WR

The default value is Disabled.

Disabled	Disabled CPU to PCI Burst Mem. WR.
Enabled	Enabled CPU to PCI Burst Mem. WR.

- MA Current Rating

The default value is Low.

Low	Set MA Current Rating is Low.
High	Set MA Current Rating is High.

- Video BIOS Cacheable

The default value is Enabled.

Enabled	Enable video BIOS cacheable.
Disabled	Disable video BIOS cacheable.

- Memory Hole at 15M-16M

The default value is Disabled .

Disabled	Normal Setting.
Enabled	Set Address=15-16MB relocate to ISA BUS.

- Refresh Cycle Time (us)

The default value is 15.6us

15.6	Set DRAM Refresh rate to 15.6us.
62.4	Set DRAM Refresh rate to 62.4us.
124.8	Set DRAM Refresh rate to 124.8us.
187.2	Set DRAM Refresh rate to 187.2us.

- RAS Pulse Width Refresh

The default value is 6T

4T	Set RAS Pulse Width Refresh to 4T.
5T	Set RAS Pulse Width Refresh to 5T.
6T	Set RAS Pulse Width Refresh to 6T.
7T	Set RAS Pulse Width Refresh to 7T.

- RAS Precharge Time

The default value is 4T

2T	Set RAS Precharge Time to 2T.
3T	Set RAS Precharge Time to 3T.
4T	Set RAS Precharge Time to 4T.
5T	Set RAS Precharge Time to 5T.

- RAS to CAS Delay

The default value is 4T

2T	Set RAS to CAS Delay to 2T.
3T	Set RAS to CAS Delay to 3T.
4T	Set RAS to CAS Delay to 4T.
5T	Set RAS to CAS Delay to 5T.

- CPU to PCI Post Write

The default value is Disabled.

3T	Set CPU to PCI Post Write to 3T.
4T	Set CPU to PCI Post Write to 4T.
Disabled	Disabled CPU to PCI Post Write.

- ISA Bus Clock Frequency

The default value is PCICLK/4.

PCICLK/3	For 50 MHz system.
PCICLK/4	For 66,60 MHz system.
7.159 MHz	Set ISA Bus clock to 7.159 MHz system.

#### 4.8. POWER MANAGEMENT SETUP

ROM PCI / ISA BIOS  
POWER MANAGEMENT SETUP  
AWARD SOFTWARE, INC.

Power Management	: Enabled	IRQ11 (Reserved)	: Disabled
Video Off Method	: DPMS Supported	IRQ12 (PS/2 Mouse)	: Enabled
** PM Timers **		IRQ14 (Hard Disk)	: Enabled
HDD Off After	: Disable	IRQ15 (Reserved)	: Enabled
Standby Mode	: Disable		
Suspend Mode	: Disable		
** PM Events **			
COM Ports Activity	: Enabled		
LPT Ports Activity	: Enabled		
HDD Ports Activity	: Enabled		
VGA Activity	: Enabled		
IRQ3 (COM 2)	: Enabled		
IRQ4 (COM 1)	: Enabled		
IRQ5 (LPT 2)	: Disabled		
IRQ6 (FLOPPY Disk)	: Enabled		
IRQ7 (LPT 1)	: Enabled		
IRQ9 (IRQ2 Redir)	: Disabled		
IRQ10 (Reserved)	: Disabled		
		ESC : Quit	↑ ↓ → ← : Select Item
		F1 : Help	PU/PD/+/- : Modify
		F5 : Old Values (Shift)	F2 : Color
		F6 : Load BIOS Defaults	
		F7 : Load Setup Defaults	

Figure 4.5: Power Management Setup

- Power Management

The default value is Enabled.

Enabled	Enable Green function.
---------	------------------------

Disabled	Disable Green function.
----------	-------------------------

Please disable Green Function for Non-S CPU in OS/2, Unix, Window NT & Novell system.

- Video off Method

The default value is DPMS Supported.

V/H SYNC+Blank	BIOS will turn off V/H-SYNC when gets into Green mode for Green monitor power saving.
Blank Screen	BIOS will only black monitor when gets into Green mode.
DPMS Supported	BIOS will use DPMS Standard to control VGA card. (The Green type VGA card will turn of V/H-SYNC automatically.)

- HDD Off After

The default value is Disable.

Disabled	Disable HDD Off After.
1min-15min	Set HDD timer to get into power down mode.

- Standby Mode

The default value is Disable.

Disable	Disable Standby Mode.
20 sec-40 min	Setup the timer to enter Standby Mode.

- Suspend Mode

The default value is Disable.

Disable	Disable Suspend Mode.
20 sec-40 min	Setup the timer to enter Suspend Mode.

- COM Ports Activity

The default value is Enabled.



Disabled	Disable COM Ports Activity.
Enabled	Enable COM Ports Activity.

- LPT Ports Activity

The default value is Enabled.

Disabled	Disable LPT Ports Activity.
Enabled	Enable LPT Ports Activity.

- HDD Ports Activity

The default value is Enabled.

Disabled	Disable HDD Ports Activity.
Enabled	Enable HDD Ports Activity.

- VGA Activity

The default value is Enabled.

Disabled	Disable VGA Activity.
Enabled	Enable VGA Activity.

- IRQX ( 3,4,5,6,7,9,10,11,12,14,15 )

The default value is Enabled.

Enabled	The system will return to normal mode from Green Mode when the IRQX is active.
Disabled	The system will not return to normal mode from Green Mode when the IRQX is active.

### 4.9. PNP/PCI CONFIGURATION

ROM PCI / ISA BIOS  
 PNP/PCI CONFIGURATION  
 AWARD SOFTWARE, INC.

Resources Controlled By	: Manual	
Reset Configuration Data	: Disabled	
IRQ-3 assigned to	: Legacy ISA	
IRQ-4 assigned to	: Legacy ISA	
IRQ-5 assigned to	: PCI/ISA PnP	
IRQ-7 assigned to	: Legacy ISA	
IRQ-9 assigned to	: PCI/ISA PnP	
IRQ-10 assigned to	: PCI/ISA PnP	
IRQ-11 assigned to	: PCI/ISA PnP	
IRQ-12 assigned to	: Legacy ISA	
IRQ-14 assigned to	: Legacy ISA	
IRQ-15 assigned to	: Legacy ISA	
		ESC : Quit    ↑ ↓ → ← : Select Item F1 : Help     PU/PD/+/- : Modify F5 : Old Values (Shift)F2 : Color F6 : Load BIOS Defaults F7 : Load Setup Defaults

Figure 4.6: PCI Slot Configuration

- Resources Controlled By

The default value is Manual.

Manual	Set Resources Controlled By Manual.
Auto	Set Resources Controlled By Auto.

- Reset Configuration Data

The default value is Disabled.

Enabled	Enabled Reset Configuration Data.
Disabled	Disabled Reset Configuration Data.

- IRQ (3,4,5,7,9,10,11,12,14,15)

The default value is "Legacy ISA" or "PCI/ISA PnP".

Legacy ISA	The resource is used by Legacy ISA device.
PCI/ISA PnP	The resource is used by PCI/ISA PnP device (PCI or ISA).

**4.10. LOAD BIOS DEFAULTS**

ROM PCI / ISA BIOS  
 COMS SETUP UTILITY  
 AWARD SOFTWARE, INC.

STANDARD CMOS SETUP	INTEGRATED PERIPHERALS
BIOS FEATURES SETUP	SUPERUSER PASSWORD
CHIPSET FEATURES SETUP	USER PASSWORD
POWER MANAGEMENT SETUP	IDE HDD AUTO DETECTION
PNP/PCI CONFIGURATION	SAVE & EXIT SETUP
LOAD BIOS DEFA	SAVING
LOAD SETUP DEFAULTS	

Load BIOS Defaults (Y/N)? N

ESC : Quit	↑ ↓ → ← : Select Item
F10 : Save & Exit Setup	(Shift)F2 : Change Color

Load BIOS Defaults except Standard CMOS SETUP

Figure 4.7: Load BIOS Defaults

- Load BIOS Defaults

To load BIOS defaults value to CMOS SRAM, enter "Y". If not, enter "N".

### 4.11. LOAD SETUP DEFAULTS

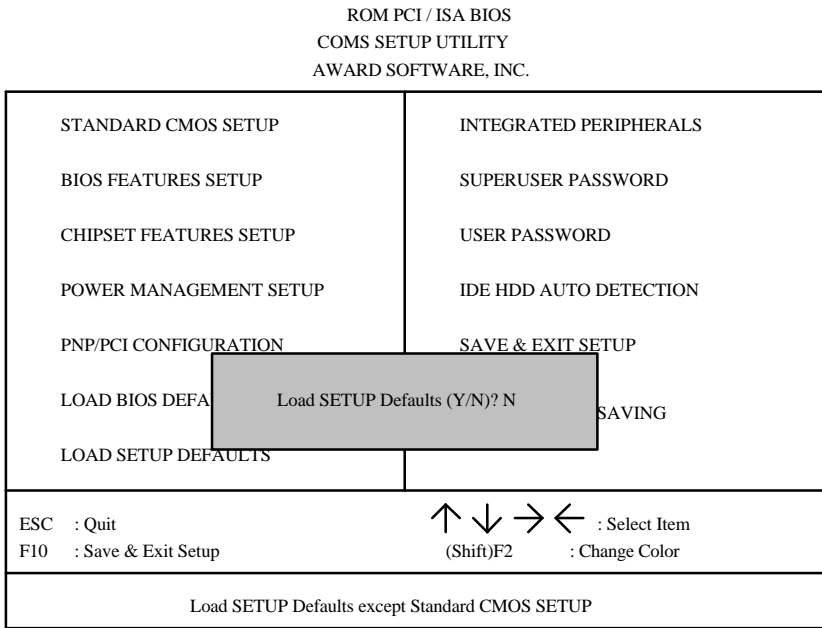

Figure 4.8: Load Setup Defaults

- Load SETUP Defaults

To load SETUP defaults value to CMOS SRAM, enter "Y". If not, enter "N".

- **If there is any problem occurred, loading BIOS DEFAULTS step is recommended.**

## 4.12. INTEGRATED PERIPHERALS

ROM PCI / ISA BIOS  
 INTEGRATED PERIPHERALS  
 AWARD SOFTWARE, INC.

Internal PCI/IDE	: Both	USB Controller	: Disable
IDE Primary Master PIO	: Auto	** USB Keyboard Support	: Disable
IDE Primary Slave PIO	: Auto		
IDE Secondary Master PIO	: Auto		
IDE Secondary Slave PIO	: Auto		
Primary Master UltraDMA	: Auto		
Primary Slave UltraDMA	: Auto		
Secondary Master UltraDMA	: Auto		
Secondary Slave UltraDMA	: Auto		
IDE Burst Mode	: Disabled		
IDE Data Port Post Write	: Enabled		
IDE HDD Block Mode	: Enabled		
Onboard FDD Controller	: Enabled		
Onboard Serial Port1	: COM1/3F8	ESC : Quit	↑ ↓ → ← : Select Item
Onboard Serial Port2	: COM2/2F8	F1 : Help	PU/PD/+/- : Modify
Onboard Parallel Port	: 378/IRQ7	F5 : Old Values (Shift)F2	: Color
Onboard Parallel Mode	: SPP	F6 : Load BIOS Defaults	
* ECP Mode Use DMA	: 3	F7 : Load Setup Defaults	

Figure 4.9: Load Setup Defaults

\* This item will show up only if On board Parallel Mode set to ECP or ECP/EPP.

\*\* This item will show up if USB Controller is enabled.

- Internal PCI/IDE

The default value is Both.

Disabled	Disabled Internal PCI/IDE .
Primary	Set Internal PCI/IDE to Primary.
Secondary	Set Internal PCI/IDE to Secondary .
Both	Set Internal PCI/IDE to Both.

- IDE Primary Master PIO (for onboard IDE 1st channel).

The default value is Auto.

Auto	BIOS will automatically detect the IDE HDD Accessing mode.
Mode0~4	Manually set the IDE Accessing mode.

- IDE Primary Slave PIO (for onboard IDE 1st channel).

The default value is Auto.

Auto	BIOS will automatically detect the IDE HDD Accessing mode.
Mode0~4	Manually set the IDE Accessing mode.

- IDE Secondary Master PIO (for onboard IDE 2nd channel).

The default value is Auto.

Auto	BIOS will automatically detect the IDE HDD Accessing mode.
Mode0~4	Manually set the IDE Accessing mode.

- IDE Secondary Slave PIO (for onboard IDE 2nd channel).

The default value is Auto.

Auto	BIOS will automatically detect the IDE HDD Accessing mode.
Mode0~4	Manually set the IDE Accessing mode.

- Primary Master UltraDMA (for onboard IDE 1st channel).

The default value is Auto.

Auto	BIOS will automatically set the IDE HDD to Ultra DMA/33 Mode.
Disabled	Disable Ultra DMA HDD Function.

- Primary Slave UltraDMA (for onboard IDE 1st channel).

The default value is Auto.

Auto	BIOS will automatically set the IDE HDD to Ultra DMA/33 Mode.
Disabled	Disable Ultra DMA HDD Function.

- Secondary Master UltraDMA (for onboard IDE 2nd channel).

The default value is Auto.

Auto	BIOS will automatically set the IDE HDD to Ultra DMA/33 Mode.
Disabled	Disable Ultra DMA HDD Function.

- Secondary Slave UltraDMA (for onboard IDE 2nd channel).

The default value is Auto.

Auto	BIOS will automatically set the IDE HDD to Ultra DMA/33 Mode.
Disabled	Disable Ultra DMA HDD Function.

- IDE Burst Mode

The default value is Disabled.

Enabled	Enable IDE Burst Mode.
Disabled	Disable IDE Burst Mode.

- IDE Data Port Post Write

The default value is Enabled.

Enabled	Enable IDE Data Port Post Write.
Disabled	Disable IDE Data Port Post Write.

- IDE HDD Block Mode

The default value is Enabled.

Enabled	Enable IDE HDD Block Mode.
Disabled	Disable IDE HDD Block Mode.

- Onboard FDD Controller

The default value is Enabled.

Enabled	Enable onboard FDD port.
Disabled	Disable onboard FDD port.

- Onboard Serial Port 1

The default value is COM1/3F8.

COM1/3F8	Enable onboard Serial port A and address is 3F8.
COM2/2F8	Enable onboard Serial port A and address is 2F8.
COM3/3E8	Enable onboard Serial port A and address is 3E8.
COM4/2E8	Enable onboard Serial port A and address is 2E8.
Disabled	Disable onboard Serial port A.
Auto	onboard Serial port A automatically set.

- Onboard Serial Port 2

The default value is COM2/2F8.

COM1/3F8	Enable onboard Serial port B and address is 3F8.
COM2/2F8	Enable onboard Serial port B and address is 2F8.
COM3/3E8	Enable onboard Serial port B and address is 3E8.
COM4/2E8	Enable onboard Serial port B and address is 2E8.
Disabled	Disable onboard Serial port B.
Auto	onboard Serial port B automatically set.

- Onboard Parallel port

The default value is 378/IRQ7.

378/IRQ7	Enable onboard LPT port and address is 378/IRQ7.
278/IRQ5	Enable onboard LPT port and address is 278/IRQ5.
3BC/IRQ7	Enable onboard LPT port and address is 3BC/IRQ7.
Disabled	Disable onboard LPT port.



- Onboard Parallel Mode

The default value is SPP.

SPP	Using Parallel port as Normal Printer Port.
EPP/SPP	Using Parallel port as Enhanced Parallel Port / Normal Printer Port.
ECP	Using Parallel port as Extended Capabilities Port. ✱
ECP/EPP	Using Parallel port as Extended Capabilities Port mode/Enhanced Parallel Port. ✱

✱ As ECP,ECP/EPP Mode is selected, two options can be defined:

1. ECP Mode use DMA: 3
2. ECP Mode use DMA: 1

- USB Controller

The default value is Disable.

Disabled	Disable USB Controller.
Enabled	Enable USB Controller.

- USB Keyboard Support

The default value is Disable.

Disabled	Disable USB Keyboard Support.
Enabled	Enable USB Keyboard Support.

### 4.13. SUPERVISOR / USER PASSWORD

When you select this function, the following message will appear at the center of the screen to assist you in creating a password.

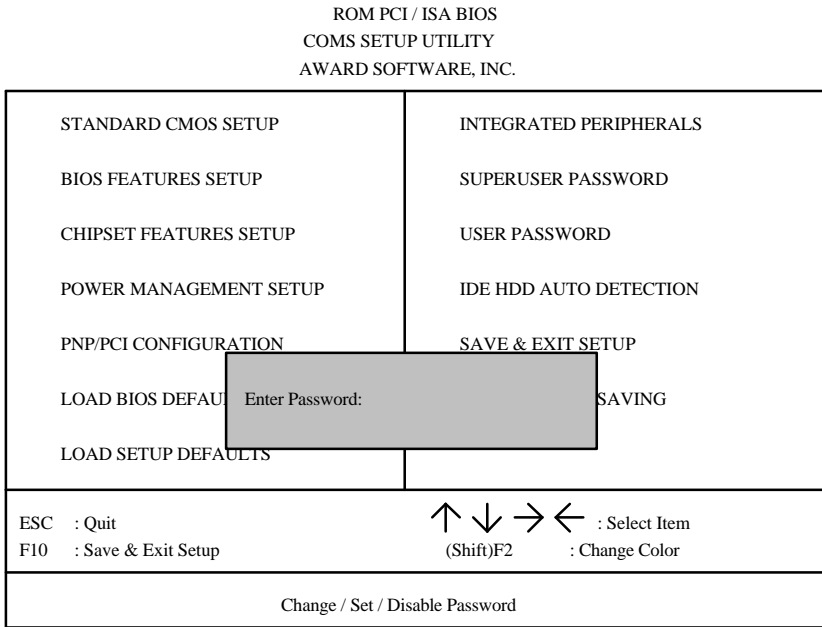

Figure 4.10: Password Setting

Type the password, up to eight characters, and press <Enter>. The password typed now will clear and previously entered password from CMOS memory.

You will be asked to confirm the password. Type the password again and press <Enter>. You may also press <Esc> to abort the selection and not enter a password.

To disable password, just press <Enter> when you are prompted to enter password. A message will confirm the password being disabled.

Once the password is disabled, the system will boot and you can enter Setup freely.

**PASSWORD DISABLED**

If you select System at Security Option of BIOS Features Setup Menu, you will be prompted for the password every time the system is rebooted or any time you try to enter Setup.

If you select Setup at Security Option of BIOS Features Setup Menu, you will be prompted only when you try to enter Setup.

**4.14. IDE HDD AUTO DETECTION**

ROM PCI / ISA BIOS  
CMOS SETUP UTILITY  
AWARD SOFTWARE, INC.

HARD DISKS	TYPE	SIZE	CYLS.	HEAD	PRECOMP	LANDZ	SECTOR	MODE
Primary Master:								
Select Primary Master Option (N=Skip): N								
OPTION	SIZE	CYLS.	HEAD	PRECOMP	LANDZ	SECTOR	MODE	
1 (Y)	521	1060	16	65535	1059	63	NORMAL	
2	521	530	32	0	1059	63	LBA	
3	521	530	32	65535	1059	63	LARGE	

Note: some OSes (like SCO-UNIX) must use "NORMAL" for installation  
ESC : Skip

Figure 4.11: IDE HDD Auto Detection

Type "Y" will accept the H.D.D. parameter reported by BIOS.

Type "N" will keep the old H.D.D. parameter setup. If the hard disk cylinder NO. is over 1024, then the user can select LBA mode or LARGER mode for DOS partition LARGER than 528 MB.

**4.15. SAVE & EXIT SETUP**

ROM PCI / ISA BIOS  
 COMS SETUP UTILITY  
 AWARD SOFTWARE, INC.

STANDARD CMOS SETUP	INTEGRATED PERIPHERALS
BIOS FEATURES SETUP	SUPERUSER PASSWORD
CHIPSET FEATURES SETUP	USER PASSWORD
POWER MANAGEMENT SETUP	IDE HDD AUTO DETECTION
PNP/PCI CONFIGURATION	SAVE & EXIT SETUP
LOAD BIOS DEFAULTS	SAVING
LOAD SETUP DEFAULTS	
SAVE to CMOS and EXIT (Y/N)? N	
ESC : Quit	↑ ↓ → ← : Select Item
F10 : Save & Exit Setup	(Shift)F2 : Change Color
Save Data to CMOS & Exit SETUP	

Figure 4.12: Save & Exit Setup

Type "Y" will quit the Setup Utility and save the user setup value to RTC CMOS SRAM.

Type "N" will return to Setup Utility.

#### 4.16. EXIT WITHOUT SAVING

ROM PCI / ISA BIOS  
 COMS SETUP UTILITY  
 AWARD SOFTWARE, INC.

STANDARD CMOS SETUP BIOS FEATURES SETUP CHIPSET FEATURES SETUP POWER MANAGEMENT SETUP PNP/PCI CONFIGURATION LOAD BIOS DEFAULTS LOAD SETUP DEFAULTS	INTEGRATED PERIPHERALS SUPERUSER PASSWORD USER PASSWORD IDE HDD AUTO DETECTION SAVE & EXIT SETUP SAVING
Quit Without Saving (Y/N)? N	
ESC : Quit F10 : Save & Exit Setup	↑ ↓ → ← : Select Item (Shift)F2 : Change Color
Abandon all Datas & Exit SETUP	

Figure 4.13: Exit Without Saving

Type "Y" will quit the Setup Utility without saving to RTC CMOS SRAM.

Type "N" will return to Setup Utility.



## 5. AT TECHNICAL INFORMATION

### 5.1. I/O BUS CONNECTOR PIN OUT

#### 5.1.1. ISA SLOT PIN OUT

GND	B01	A01	-I/O CH CHK
RESET	B02	A02	SD07
+5V	B03	A03	SD06
IRQ9	B04	A04	SD05
-5V	B05	A05	SD04
DRQ2	B06	A06	SD03
-12V	B07	A07	SD02
0WS	B08	A08	SD01
+12V	B09	A09	SD00
GND	B10	A10	-I/O CH RDY
-SMEMW	B11	A11	AEEN
-SMEMR	B12	A12	SA19
-IOW	B13	A13	SA18
-IOR	B14	A14	SA17
-DACK3	B15	A15	SA16
-DRQ3	B16	A16	SA15
-DACK1	B17	A17	SA14
-DRQ1	B18	A18	SA13
-REFRESH	B19	A19	SA12
BCLK	B20	A20	SA11
IRQ7	B21	A21	SA10
IRQ6	B22	A22	SA09
IRQ5	B23	A23	SA08
IRQ4	B24	A24	SA07
IRQ3	B25	A25	SA06
-DACK2	B26	A26	SA05
T/C	B27	A27	SA04
BALE	B28	A28	SA03
+5V	B29	A29	SA02
OSC	B30	A30	SA01
GND	B31	A31	SA00
-MEMCS16	D01	C01	SBHE
-I/OCS16	D02	C02	LA23
IRQ10	D03	C03	LA22
IRQ11	D04	C04	LA21
IRQ12	D05	C05	LA20
IRQ15	D06	C06	LA19
IRQ14	D07	C07	LA18
-DACK0	D08	C08	LA17
DRQ0	D09	C09	-MEMR
-DACK5	D10	C10	-MEMW
DRQ5	D11	C11	SD08
-DACK6	D12	C12	SD09
DRQ6	D13	C13	SD10
-DACK7	D14	C14	SD11
DRQ7	D15	C15	SD12
+5V	D16	C16	SD13
-MASTER	D17	C17	SD14
GND	D18	C18	SD15

## 5.1.2. PCI - BUS SLOT PIN OUT

-12V	B01	A01	NC
NC	B02	A02	+12V
GND	B03	A03	NC
NC	B04	A04	NC
VCC	B05	A05	VCC
VCC	B06	A06	INTA#
INTB#	B07	A07	INTC#
INTD#	B08	A08	VCC
PST#1	B09	A09	NC
NC	B10	A10	VCC
PST#2	B11	A11	NC
GND	B12	A12	GND
GND	B13	A13	GND
NC	B14	A14	NC
GND	B15	A15	RST#
CLK	B16	A16	VCC
GND	B17	A17	GNT#
REQ#	B18	A18	GND
VCC	B19	A19	NC
AD_31	B20	A20	AD_30
AD_29	B21	A21	NC
GND	B22	A22	AD_28
AD_27	B23	A23	AD_26
AD_25	B24	A24	GND
NC	B25	A25	AD_24
CBE#3	B26	A26	IDSEL
AD_23	B27	A27	NC
GND	B28	A28	AD_22
AD_21	B29	A29	AD_20
AD_19	B30	A30	GND
NC	B31	A31	AD_18
AD_17	B32	A32	AD_16
CEB#2	B33	A33	NC
GND	B34	A34	FRAME#
IRDY#	B35	A35	GND
NC	B36	A36	TRDY#
DEVSEL#	B37	A37	GND
GND	B38	A38	STOP#
LOCK#	B39	A39	NC
PERR#	B40	A40	SDONE
NC	B41	A41	SBO#
SERR#	B42	A42	GND
NC	B43	A43	PAR
CBE#1	B44	A44	AD_15
AD_14	B45	A45	NC
GND	B46	A46	AD_13
AD_12	B47	A47	AD_11
AD_10	B48	A48	GND
GND	B49	A49	AD_09
AD_08	B52	A52	CBE#0
AD_07	B53	A53	NC
NC	B54	A54	AD_06
AD_05	B55	A55	AD_04
AD_03	B56	A56	GND
GND	B57	A57	AD_02
AD_01	B58	A58	AD_00
VCC	B59	A59	VCC
NC	B60	A60	NC
VCC	B61	A61	VCC
VCC	B62	A62	VCC



## 5.2. I/O & MEMORY MAP

MEMORY MAP:	[0000000-009FFFFF]	System memory used by DOS and application program.
	[00A0000-00BFFFFF]	Display buffer memory for VGA/ EGA/CGA/MONOCHROME adapter.
	[00C0000-00DFFFFF]	Reserved for I/O device BIOS ROM or RAM buffer.
	[00E0000-00EFFFFF]	Reserved for PCI device ROM.
	[00F0000-00FFFFFF]	System BIOS ROM.
	[0100000-BFFFFFFF]	System extension memory.
I/O MAP:	[000-01F]	DMA controller.(Master)
	[020-021]	INTERRUPT controller.(Master)
	[022-023]	CHIPSET control registers I/O ports.
	[040-05F]	TIMER control registers.
	[060-06F]	KEYBOARD interface controller.(8042)
	[070-07F]	RTC ports & CMOS I/O ports.
	[080-09F]	DMA register.
	[0A0-0BF]	INTERRUPT controller.(Slave)
	[0C0-0DF]	DMA controller.(Slave)
	[0F0-0FF]	MATH COPROCESSOR
	[1F0-1F8]	HARD DISK controller.
	[278-27F]	PARALLEL port-2.
	[2B0-2DF]	GRAPHICS adapter controller.
	[2F8-2FF]	SERIAL port-2.
	[360-36F]	NETWORK ports.
	[378-37F]	PARALLEL port-1
	[3B0-3BF]	MONOCHROME & PRINTER adapter.
	[3C0-3CF]	EGA adapter.
	[3D0-3DF]	CGA adapter.
	[3F0-3F7]	FLOPPY DISK controller.
	[3F8-3FF]	SERIAL port-1.

## 5.3. TIMER & DMA CHANNELS MAP

TIMER MAP:           TIMER Channel-0 System timer interrupt  
 TIMER Channel-1 DRAM REFRESH request  
 TIMER Channel-2 SPEAKER tone generator

DMA CHANNELS:      DMA Channel-0 Available  
 DMA Channel-1 IBM SDLC  
 DMA Channel-2 FLOPPY DISK adapter  
 DMA Channel-3 Available  
 DMA Channel-4 Cascade for DMA controller 1  
 DMA Channel-5 Available  
 DMA Channel-6 Available  
 DMA Channel-7 Available

## 5.4. INTERRUPT MAP

NMI: Parity check error

IRQ (H/W): 0 System TIMER interrupt from TIMER-0

1 KEYBOARD output buffer full

2 Cascade for IRQ 8-15

3 SERIAL port 2

4 SERIAL port 1

5 PARALLEL port 2

6 FLOPPY DISK adapter

7 PARALLEL port 1

8 RTC clock

9 Available

10 Available

11 Available

12 P/S 2 Mouse

13 MATH coprocessor

14 HARD DISK adapter

15 Available

### 5.5. RTC & CMOS RAM MAP

RTC & CMOS:	00	Seconds
	01	Second alarm
	02	Minutes
	03	Minutes alarm
	04	Hours
	05	Hours alarm
	06	Day of week
	07	Day of month
	08	Month
	09	Year
	0A	Status register A
	0B	Status register B
	0C	Status register C
	0D	Status register D
	0E	Diagnostic status byte
	0F	Shutdown byte
	10	FLOPPY DISK drive type byte
	11	Reserve
	12	HARD DISK type byte
	13	Reserve
	14	Equipment byte
	15	Base memory low byte
	16	Base memory high byte
	17	Extension memory low byte
	18	Extension memory high byte
	19-2d	
	2E-2F	
	30	Reserved for extension memory low byte
	31	Reserved for extension memory high byte
	32	DATE CENTURY byte
	33	INFORMATION FLAG
	34-3F	Reserve
	40-7f	Reserved for CHIPSET SETTING DATA



## APPENDIX A: POST MESSAGE

When the BIOS encounters an error that requires the user to correct something, either a beep code will sound or a message will be displayed in a box in the middle of the screen and the message PRESS F1 TO CONTINUE, CTRL-ALT-ESC OR DEL TO ENTER SETUP will be shown in the information box at the bottom.

- POST BEEP

Currently there is only one beep code in BIOS. This code indicates that a video error has occurred and the BIOS cannot initialize the video screen to display any additional information. This beep code consists of a single long beep followed by two short beeps.

- ERROR MESSAGE

Once or more of the following messages may be displayed if the BIOS detects an error during the POST. This list includes message for both the ISA and the EISA BIOS.

- ☒ CMOS BATTERY HAS FAILED

CMOS battery is no longer functional. It should be replaced.

- ☒ CMOS CHECKSUM ERROR

Checksum of CMOS is incorrect. This can indicate that CMOS has become corrupt. This error may have been caused by a weak battery. Check the battery and replace if necessary.

- ☒ DISK BOOT FAILURE, INSERT SYSTEM DISK AND PRESS ENTER

No boot device was found. Insert a system disk into Drive A: and press <Enter>. If you assumed the system would boot from the hard drive, make sure the controller is inserted correctly and all cables are properly attached. Also be sure the disk is formatted as a boot device. Then reboot the system.

⊗ DISKETTE DRIVES OR TYPES MISMATCH ERROR - RUN SETUP

Type of diskette drive installed in the system is different from the CMOS definition. Run Setup to re-configure the drive type correctly.

⊗ DISPLAY SWITCH IS SET INCORRECTLY

Display switch on the motherboard can be set to either monochrome or color. This indicates the switch is set to a different setting than indicated in Setup.

Determine which setting is correct, and then either turn off the system and change the jumper, or enter Setup and change the VIDEO selection.

⊗ DISPLAY TYPE HAS CHANGED SINCE LAST BOOT

Since last powering off the system, the display adapter has been changed. You must configure the system for the new display type.

⊗ EISA Configuration Checksum Error

PLEASE RUN EISA CONFIGURATION UTILITY

The EISA non-volatile RAM checksum is incorrect or cannot correctly read the EISA slot. This can indicate either the EISA non-volatile memory has become corrupt or the slot has configured incorrectly. Also be sure the card is installed firmly in the slot.

⊗ EISA Configuration Is Not Complete

PLEASE RUN EISA CONFIGURATION UTILITY

The slot configuration information stored in the EISA non-volatile memory is incomplete.

☞ When either of these errors appear, the system will boot in ISA mode, which allows you to run the EISA Configuration Utility.

⊗ ERROR ENCOUNTERED INITIALIZING HARD DRIVE

Hard drive cannot be initialized. Be sure the adapter is installed correctly and all cables are correctly and firmly attached. Also be sure the correct hard drive type is selected in Setup.

⊗ ERROR INITIALIZING HARD DISK CONTROLLER

Cannot initialize controller. Make sure the cord is correctly and firmly installed in the bus. Be sure the correct hard drive type is selected in Setup. Also check to see if any jumper needs to be set correctly in the hard drive.

⊗ FLOPPY DISK CNTRLR ERROR OR NO CNTRLR PRESENT

Cannot find or initialize the floppy drive controller. Make sure the controller is installed correctly and firmly. If there are no floppy drives installed, be sure the Diskette Drive selection in Setup is set to NONE.

⊗ Invalid ISA Configuration

PLEASE RUN EISA CONFIGURATION UTILITY

The non-volatile memory containing EISA configuration information was programmed incorrectly or has become corrupt. Re-run EISA configuration utility to program the memory correctly.

☞ When this error appears, the system will boot in ISA mode, which allows you to run the EISA Configuration Utility.

⊗ KEYBOARD ERROR OR NO KEYBOARD PRESENT

Cannot initialize the keyboard. Make sure the keyboard is attached correctly and no key is being pressed during the boot.

If you are purposely configuring the system without a keyboard, set the error halt condition in Setup to HALT ON ALL, BUT KEYBOARD. This will cause the BIOS to ignore the missing keyboard and continue the boot.

⊗ Memory Address Error at ...

Indicates a memory address error at a specific location. You can use this location along with the memory map for your system to find and replace the bad memory chips.

⊗ Memory parity Error at ...

Indicates a memory parity error at a specific location. You can use this location along with the memory map for your system to find and replace the bad memory chips.

☒ MEMORY SIZE HAS CHANGED SINCE LAST BOOT

Memory has been added or removed since the last boot. In EISA mode use Configuration Utility to re-configure the memory configuration.

In ISA mode enter Setup and enter the new memory size in the memory field.

☒ Memory Verify Error at ...

Indicates an error verifying a value already written to memory. Use the location along with your system's memory map to locate the bad chip.

☒ OFFENDING ADDRESS NOT FOUND

This message is used in conjunction with the I/O CHANNEL CHECK and RAM PARITY ERROR messages when the segment that has caused the problem cannot be isolated.

☒ OFFENDING SEGMENT:

This message is used in conjunction with the I/O CHANNEL CHECK and RAM PARITY ERROR messages when the segment that has caused the problem has been isolated.

☒ PRESS A KEY TO REBOOT

This will be displayed at the bottom screen when an error occurs that requires you to reboot. Press any key and the system will reboot.

☒ PRESS F1 TO DISABLE NMI, F2 TO REBOOT

When BIOS detects a Non-miscible Interrupt condition during boot, this will allow you to disable the NMI and continue to boot, or you can reboot the system with the NMI enabled.

☒ RAM PARITY ERROR - CHECKING FOR SEGMENT ...

Indicates a parity error in Random Access Memory.

☒ Should Be Empty But ISA Board Found

PLEASE RUN EISA CONFIGURATION UTILITY

A valid board ID was found in a slot that was configured as having no board ID.

☞ When this error appears, the system will boot in ISA mode, which allows you to run the EISA Configuration Utility.



⊗ Should Have ISA Board But Not Found

PLEASE RUN EISA CONFIGURATION UTILITY

The board installed is not responding to the ID request, or no board ID has been found in the indicated slot.

☞ When this error appears, the system will boot in ISA mode, which allows you to run the EISA Configuration Utility.

⊗ Slot Not Empty

Indicates that a slot designated as empty by the EISA Configuration Utility actually contains a board.

☞ When this error appears, the system will boot in ISA mode, which allows you to run the EISA Configuration Utility.

⊗ SYSTEM HALTED, (CTRL-ALT-DEL) TO REBOOT ...

Indicates the present boot attempt has been aborted and the system must be rebooted. Press and hold down the CTRL and ALT keys and press DEL.

⊗ Wrong Board In Slot

PLEASE RUN EISA CONFIGURATION UTILITY

The board ID does not match the ID stored in the EISA non-volatile memory.

☞ When this error appears, the system will boot in ISA mode, which allows you to run the EISA Configuration Utility.



## APPENDIX B: POST CODES

☞ EISA POST codes are typically output to port address 300h. ISA POST codes are typically output to port address 80h.

POST	Name	Description
C0	Turn Off Chipset Cache	OEM Specific-Cache control.
1	Processor Test 1	Processor Status (1 FLAGS) Verification. Test the following processor status flags carry, zero, sign, overflow, The BIOS will set each of these flags, verify they are set, then turn each flag off and verify it is off.
2	Processor Test 2	Read/Write/Verify all CPU registers except SS, SP, and BP with data pattern FF and 00.
3	Initialize Chips	Disable NMI, PIE, AIE, UEI, SQWV. Disable video, parity checking, DMA. Reset math coprocessor. Clear all page registers, CMOS shutdown byte. Initialize timer 0, 1, and 2, including set EISA timer to a known state. Initialize DMA controllers 0 and 1. Initialize interrupt controllers 0 and 1. Initialize EISA extended registers.
4	Test Memory Refresh Toggle	RAM must be periodically refreshed in order to keep the memory from decaying. This function assures that the memory refresh function is working properly.
5	Blank video, Initialize keyboard	Keyboard controller initialization.
6	Reserved	
7	Test CMOS Interface and Battery Status	Verifies CMOS is working correctly, detects bad battery.
BE	Chipset Default Initialization	Program chipset registers with power on BIOS defaults.
C1	Memory presence test	OEM Specific-Test to size on-board memory.
C5	Early Shadow	OEM Specific-Early Shadow enable for fast boot.
C6	Cache presence test	External cache size detection.

8	Setup low memory	Early chip set initialization. Memory presence test. OEM chip set routines. Clear low 64 K of memory. Test first 64 K memory.
9	Early Cache Initialization	Cyrix CPU initialization. Cache initialization.
A	Setup Interrupt Vector Table	Initialize first 120 interrupt vectors with SPURIOUS_INT-HDLR and initialize INT 00h-1Fh according to INT_TBL.
B	Test CMOS RAM Checksum	Test CMOS RAM Checksum, if bad, or insert key pressed, load defaults.
C	Initialize keyboard	Detect type of keyboard controller (optional). Set NUM_LOCK status.
D	Initialize Video Interface	Detect CPU clock. Read CMOS location 14h to find out type of video in use. Detect and Initialize Video Adapter.
E	Test Video Memory	Test video memory, write sign-on message to screen. Setup shadow RAM - Enable shadow according to Setup.
F	Test DMA Controller 0	BIOS checksum test. Keyboard detect and initialization.
10	Test DMA Controller 1	
11	Test DMA Page registers	Test DMA Page Registers.
12-13	Reserved	
14	Test Timer Counter 2	Test 8254 Timer 0 Counter 2.
15	Test 8259-1 Mask Bits	Verify 8259 Channel 1 masked interrupts by alternately turning off and on the interrupt lines.
16	Test 8259-2 Mask Bits	Verify 8259 Channel 2 masked interrupts by alternately turning off and on the interrupt lines.
17	Test Stuck 8259's Interrupt Bits	Turn off interrupts then verify no interrupt mask register is on.
18	Test 8259 Interrupt Functionality	Force an interrupt and verify the interrupt occurred.

Appendix B: Post Codes

19	Test Stuck NMI Bits (Parity/IO Check)	Verify NMI can be cleared.
1A		Display CPU clock.
1B-1E	Reserved	
1F	Set EISA Mode	If EISA non-volatile memory checksum is good, execute EISA initialization. If not, execute ISA tests and clear EISA mode flag. Test EISA Configuration Memory Integrity (checksum & communication interface).
20	Enable Slot 0	Initialize slot 0 (System Board).
21-2F	Enable Slots 1-15	Initialize slot 1 through 15.
30	Size Base and Extended Memory	Size base memory from 256 K to 640 K extended memory above 1 MB.
31	Test Base and Extended Memory	Test base memory from 256 K to 640 K and extended memory above 1 MB using various patterns. ☞ This will be skipped in EISA mode and can be "skipped" with ESC key in ISA mode.
32	Test EISA Extended Memory	If EISA Mode flag is set then test EISA memory found in slots initialization. ☞ This will be skipped in ISA mode and can be "skipped" with ESC key in EISA mode.
33-3B	Reserved	
3C	Setup Enabled	
3D	Initialize & Install Mouse	Detect if mouse is present, initialize mouse, install interrupt vectors.
3E	Setup Cache Controller	Initialize cache controller.
3F	Reserved	
BF	Chipset Initialization	Program chipset registers with Setup values.
40		Display virus protest disable or enable.
41	Initialize Floppy Drive & Controller	Initialize floppy disk drive controller and any drive.
42	Initialize Hard Drive & Controller	Initialize hard drive controller and any drive.
43	Detect & Initialize Serial/Parallel Ports	Initialize any serial and parallel port (also game port).
44	Reserved	
45	Detect & Initialize Math Coprocessor	Initialize math coprocessor.

46	Reserved	
47	Reserved	
48-4D	Reserved	
4E	Manufacturing POST Loop or Display Messages	Reboot if Manufacturing POST Loop pin is set. Otherwise display any message (i.e., any non-fatal error that was detected during POST) and enter Setup.
4F	Security Check	Ask password security (optional).
50	Write CMOS	Write all CMOS values back to RAM and clear screen.
51	Pre-boot Enable	Enable parity checker. Enable NMI, Enable cache before boot.
52	Initialize Option ROMs	Initialize any option ROMs present from C8000h to EFFFFh. ☞ When FSCAN option is enabled, will initialize from C8000h to F7FFFh.
53	Initialize Time Value	Initialize time value in 40h: BIOS area.
60	Setup Virus Protect	Setup virus protect according to Setup
61	Set Boot Speed	Set system speed for boot
62	Setup NumLock	Setup NumLock status according to Setup
63	Boot Attempt	Set low stack. Boot via INT 19h.
B0	Spurious	If interrupt occurs in protected mode.
B1	Unclaimed NMI	If unmasked NMI occurs, display Press F1 to disable NMI, F2 reboot.
E1-EF	Setup Pages	E1 - Page 1, E2 - Page 2, etc.
FF	Boot	

## APPENDIX C: PROBLEM SHEET

### 1. Customer Data

Name  
Address  
Tel. No.  
Fax. No.  
Purchase Date

### 2. Mainboard Date

Model NO. GA-  
Serial No. Rev. No.

### 3. System Configuration

CPU Type:  
CPU Brand:  
CPU Speed:  
DRAM Type:  1  2  4  8  16  32 MB  
DRAM Speed:  80  70  60 ns  
DRAM Total Size: MB  
DRAM Brand:  
SRAM Size:  64KB  128 KB  256 KB  512 KB  
SRAM Part No. TAG: DATA:  
Video Card:  
Video Chip or Brand:  
Floppy Drive A Capacity & Brand:  
Floppy Drive B Capacity & Brand:  
Storage Controller Type  MFM  RLL  IDE  EDSI  SCSI  
Hard Drive C Brand & Type:  
Hard Drive D Brand & Type:  
LAN Controller Type:  
LAN Card Brand & Model:  
Serial / Parallel Chip Brand & Model:  
Mouse Brand & Model:  
O.S.  DOS  OS/2  NETWARE  UNIX / XENIX Ver.:

### 4. AUTOEXEC.BAT & CONFIG.SYS File:

### 5. Problem Description:

R-10-03-070930





## APPENDIX D: FCC DOCUMENT

<p><b>DECLARATION OF CONFORMITY</b> Per FCC Part 2 Section 2.1077(a)</p> <p><b>FCC</b></p> <p>Responsible Party Name: G.B.T. INC. Address: 13365 Valley Blvd., Suite#A LA Puente, CA 91744 Phone/Fax No: (818) 854-9338/ (818) 854-9339</p> <p>I hereby declare that the product Product Name: Mother Board Model Number: GA-586STX</p> <p>Conforms to the following specifications: FCC Part 15, Subpart B, Section 15.107(a) and Section 15.109(a), Class B Digital Device</p> <p><b>Supplementary Information:</b> This device complies with part 15 of the FCC Rules. Operation is subject to the following two conditions: (1) This device may not cause harmful interference, and (2) this device must accept any interference received, including interference that may cause undesired operation.</p> <p>Representative Person's Name: <u>ERIC LU</u> Signature: <u>ERIC LU</u> Date: <u>SEP 07 1997</u></p>
--

### FCC Compliance Statement:

This equipment has been tested and found to comply with limits for a Class B digital device, pursuant to Part 15 of the FCC rules. These limits are designed to provide reasonable protection against harmful interference in residential installations. This equipment generates, uses, and can radiate radio frequency energy, and if not installed and used in accordance with the instructions, may cause harmful interference to radio communications.

However, there is no guarantee that interference will not occur in a particular installation. If this equipment does cause interference to radio or television equipment reception, which can be determined by turning the equipment off and on, the user is encouraged to try to correct the interference by one or more of the following measures:

- Reorient or relocate the receiving antenna
- Move the equipment away from the receiver
- Plug the equipment into an outlet on a circuit different from that to which the receiver is connected
- Consult the dealer or an experienced radio/television technician for additional suggestions

You are cautioned that any change or modifications to the equipment not expressly approve by the party responsible for compliance could void Your authority to operate such equipment.

This device complies with Part 15 of the FCC Rules. Operation is subjected to the following two conditions:1) This device may not cause harmful interference and 2) this device must accept any interference received, including interference that may cause undesired operation.